

DRO System

Bulletin No. 1715



Linear Scales & Counters

Accuracy, yet Affordable, DRO System is Available with Linear Scales and Counters!

AT115 • AT102 • AT111 • AT112 • AT181

KL Counter • KLL Counter • KM Counter • KC Counter • KS Counter • KLD Counter

Mitutoyo's DRO (Digital Readout) system integrates the AT100 Series Linear Scales (AT115/AT102/AT111/AT112/AT181) with the K Series dedicated digital counters (KL/KLL/KM/KC/KS/KLD Counter), to offer accurate detection and display of axial displacements of machine tools and measuring equipment. The DRO system can be configured to best meet your specific application, such as turning, milling, or grinding. Choose a suitable combination of scale unit and counter. Scale units have diverse measuring length ranges and counters feature remote zero setting, switchable resolution, and multipurpose one-touch macro keys. The DRO system has superior ease-of-use and is reliable, both of which dramatically improve machining accuracy and efficiency. Mitutoyo strongly recommends implementation of the DRO system wherever possible.



With the DRO system, you can:

1. Simplify machining procedure.

Procedures such as layout and setup can be completely omitted and simplified.

2. Shorten machining time.

In addition to simplifying machining procedure, the operator is free from the drudgery of measuring dimensions, positioning, and calculating feeding lengths, greatly shortening the time required for machining. The more complicated the machining procedure, the more effective the DRO system is as a time-saver.

3. Reduce errors.

The counter clearly displays the travel and the cutting depth, thereby reducing such errors as misreading of graduation, miscounting of knob rotation, and miscalculation of dimensions. Dimensions are always consistent and are independent of operators.

4. Eliminate manual calculations.

The counter's calculation function will display dimensions such as diameters of a rotating workpiece in design drawing notation if machine feed knob is turned.

5. Reduce machining costs.

Streamlined, labor-saving, and defective-free machining drastically reduces machining costs.

Ultra Precision Manufacture Eleven Meters Underground

Mitutoyo Kiyohara Plant, which is a factory exclusively for the production of Linear Scales and other precision scales, has a complete system for producing master scales to be used in finished products, such as CMM, vision measuring system, profile projectors, and measuring microscopes. To improve the accuracy of scales and quality control technologies, the integral laboratory of Kiyohara Plant was constructed eleven meters underground. It provides an optimum environment (cleanliness factor: 100) for the ultra-precision manufacture and evaluation of scales. Its unique design and construction isolate the laboratory from external vibrations and ensure minimal variations in temperature and humidity.



Products with CE Marking

Each model of Mitutoyo Linear Scales and counters bears the CE mark. CE stands for Conformité Européenne. It indicates that the product complies with the requirements drawn up by the European Community for safety, health, environment and customer protection.



Traceability System of Mitutoyo

Mitutoyo, a manufacturer of precision measuring instruments, offers a wide range of measuring machines and instruments that are in full compliance with the national standards of various countries. They are traceable to the national standards through the physical standards, which are calibrated by specified secondary standards owned by Mitutoyo. Our calibration laboratories are accredited to provide calibration services in three fields of length-measurement: length-measuring laser units, gauge blocks, and line standards.

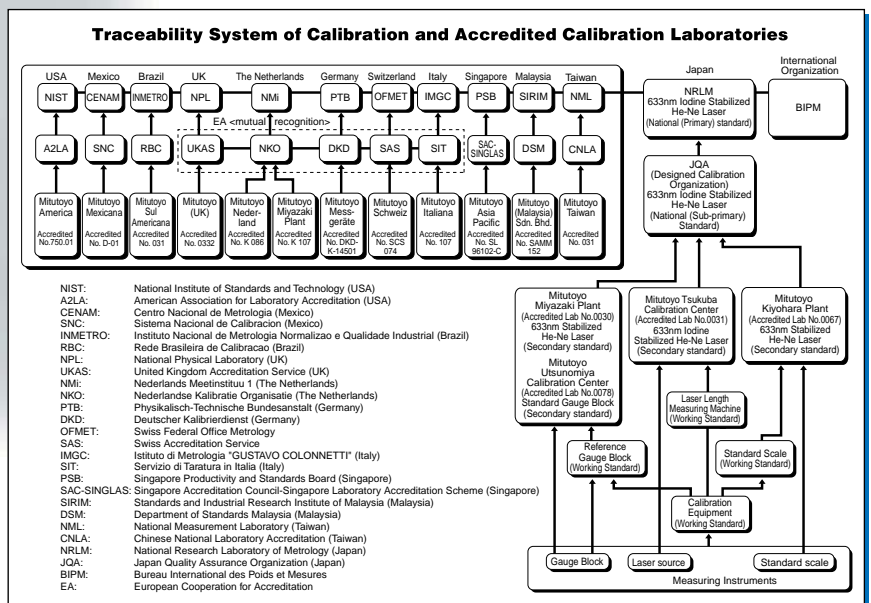

DRO System Using Mitutoyo Linear Scales

*KM Counter is not available in the US market.

Display Units

KL Counter

Standard Type
for Milling Machine

mm/inch 1-AXIS
2-AXIS
3-AXIS



KLL Counter

Standard Type
for Lathe

mm/inch 3-AXIS



KM Counter*

Multi-function Type

mm/E 1-AXIS
mm/inch 2-AXIS
3-AXIS



KC Counter

Multi-function Type with Data Output

mm/E 1-AXIS
mm/inch 2-AXIS
3-AXIS



KS Counter

Basic Type

mm/E 1-AXIS
mm/inch 2-AXIS
3-AXIS



KLD Counter

Special Purpose Type
with Limit Signal Output

mm/inch 1-AXIS



2-STEP LIMIT
4-STEP LIMIT



8-STEP LIMIT

Scale Units

Linear Scale AT115

Slim Spar
From 100mm up to 1,500mm

STANDARD



Linear Scale AT102

Standard-size Spar
From 100mm up to 6,000mm

STANDARD
HIGH-ACCURACY



Linear Scale AT111

Slim Spar
From 100mm up to 1,500mm

STANDARD
HIGH-ACCURACY

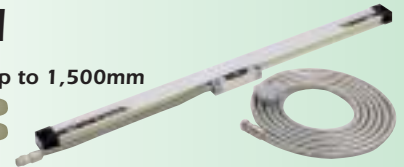

Linear Scale AT112

Super Slim Spar
From 50mm up to 1,020mm

STANDARD
HIGH-ACCURACY

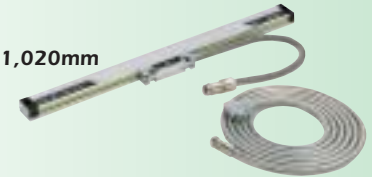

Linear Scale AT181

Panger Type
From 100mm up to 600mm

STANDARD
HIGH-ACCURACY



Extension Cables

Type A†
2m (09AAA033A)
5m (09AAA033B)
7m (09AAA033C)

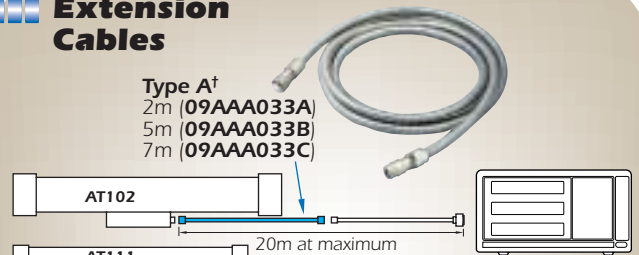

Type B
2m (09AAA720A)
5m (09AAA720B)
7m (09AAA720C)

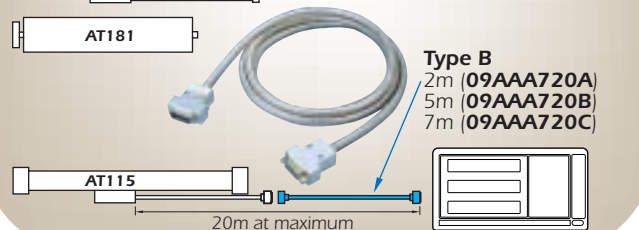

Display Unit Functions

Types of Display Units

Functions	KL Counter (See page 9.)	KLL Counter (See page 10.)	KM Counter (See page 11.)	KC Counter (See page 12.)	KS Counter (See page 14.)	KLD Counter (See page 15.)	
ZERO Zero-Setting	●	●	●	●	●	●	See page 6.
Zero-set remote controller			●	●	●		See page 6.
P.SET Preset	●	●	●	●	●	●	See page 6.
Resolution setting	● ^{*1}	● ^{*1}	● ^{*1}	● ^{*1}	● ^{*1}	● ^{*1}	See page 6.
Counting direction setting	●	●	●	●	●	●	See page 6.
mm/inch conversion	●	●	●	●	●	●	See page 6.
1/2 calculation	●	●	●	●	●	●	See page 6.
ABS/INC coordinate selection	● ^{*2}	● ^{*2}	● ^{*2}	● ^{*2}	● ^{*2}		See page 6.
123 Lower digit blanking out	●	●	●	●	●	●	See page 6.
Memory backup	●	●	●	●	●	●	See page 6.
Expansion/contraction coefficient setting			●	●		●	See page 6.
Zero approach machining [ABS mode]			●	●			See page 6.
Zero approach machining [INC mode]	●	●	●	●			See page 6.
Bolt-hole circle machining	● ^{*3}		● ^{*3}	● ^{*3}			See page 6.
Touch-signal probe	●		●	●		●	See page 7.
Scale reference point setting	●	●	●	●		●	See page 7.
+ Addition/subtraction			●	●			See page 7.
MAX/MIN Maximum/minimum value hold						●	See page 7.
DIA Diameter display	●	●	●	●	●	●	See page 7.
Z1+Z2 Addition of 2-scale data	● ^{*4}	● ^{*4}	● ^{*4}	● ^{*4}	● ^{*4}		See page 7.
Direct data entry with Digimatic gage			●	●			See page 7.
TOOL Cutting tool selection		● ^{*5}	● ^{*5}	● ^{*5}			See page 7.
Coordinate data copy			●	●			See page 7.
MACRO One-touch macro key			●	●			See page 8.
PROG. Part-program setting			●	●			See page 8.
Programmable remote controller			●	●			See page 8.
Linearity error compensation	●	●	●	●	●	●	See page 8.
Pitch error compensation			●	●			See page 8.
Lost motion compensation			●	●			See page 8.
1234 Smoothing		●	●	●	●	●	See page 8.
RS-232C OUTPUT RS-232C Interface Unit	●	●		●	●	●	See page 8.
LIMIT RS-232C Limit signal output via RS-232C				●			
BCD OUTPUT BCD Code Out				●		●	See page 8.
DIGIMATIC OUTPUT Digimatic Code Out				●			See page 8.
GP-IB OUTPUT GP-IB Interface				●			See page 8.
LIMIT OUTPUT Limit signal output				●		●	See page 8.

● : Provided as standard

● : Optional accessory

*1 Resolutions to be set differ depending upon the type of Counters.

*2 6 absolute (ABS) coordinates and 5 incremental (INC) coordinates are provided for the KM/KC Counter.

1 absolute (ABS) coordinate and 1 incremental (INC) coordinate are provided for the KL/KLL/KS Counter.

*3 Not available on the 1-axis Counters.

*4 Not available on the 1-axis Counters and the 2-axis KL Counter.

*5 5 cutting tools can be specified on the KM/KC Counter. 10 cutting tools can be specified on the KLL Counter.

BASIC FUNCTIONS

ZERO Zero-setting

The display can be set to "0" (zero) at any scale position.



Zero-set remote controller

The optional zero set remote controller (09CAA335) allows the displayed value to be remotely zero set.



P.SET Preset

This function allows the user to enter a numeric value on the counter display. Any preset value can be retrieved whenever necessary.

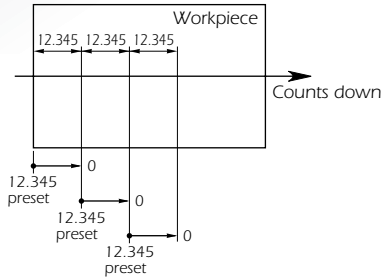

0.001 / 0.01 Resolution setting

The most easy-to-read resolution can be selected to meet measuring applications. Available resolutions depend upon the Counter to be used.

Counting direction setting

The counting up direction can be selected.

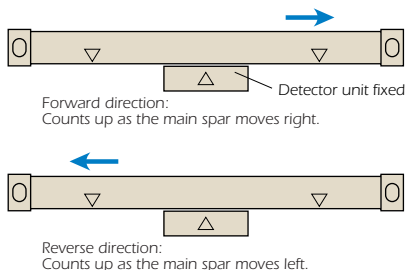

mm/E mm/inch conversion

The counting unit can be changed between "mm" and "inch" (or between "mm" and "E (=1/25.4mm)" depending on the model.)

1/2 1/2 calculation

This function halves the display value.

Absolute/incremental coordinate selection

For each axis, the measured value can be obtained in either absolute (ABS) or incremental (INC) coordinate system. This function is useful, for example, if the following operation is performed. Set the datum point for a workpiece in the absolute mode. Then, after performing zero setting, presetting, etc., in the incremental mode, return to the absolute mode. In this way the absolute distance from the datum point can be easily displayed.

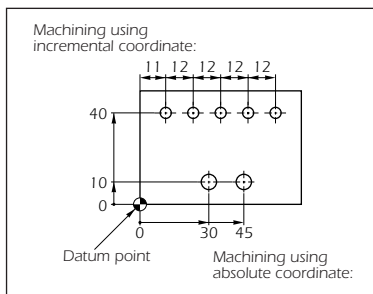
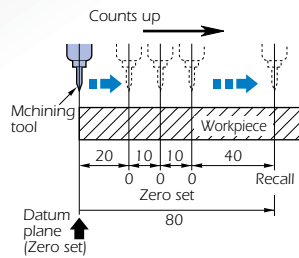

123 Lower digit blanking out

Unnecessary lower digits (up to 9 digits of the lowest digits) can be blanked out.

Memory backup

The backup battery retains the most recent display value even when the counter is off.

Expansion/contraction coefficient setting

This function compensates for the expansion/contraction of a melted material in a mold within a range of -20% to 20%.

FOR MILLING MACHINES

Zero approach machining [INC mode]

Zero approach machining can be repeated at a preset interval without error. Since the counter keeps the total displacement in the absolute coordinate system, the error is automatically compensated for at each tool position.

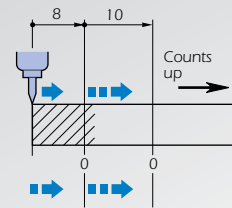
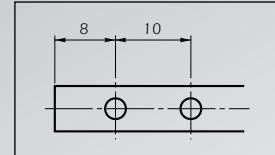

Zero approach machining [ABS mode]

In milling, the tool can be positioned with the following method: first preset the distance from the current tool position to the machining position, then feed the table until the counter value reads zero. This method of machining is called "zero approach machining". Since this method maintains consistency with the drawing, effective machining operations can be made error-free. (There are two zero approach machining modes: incremental zero approach mode and absolute zero approach mode.)

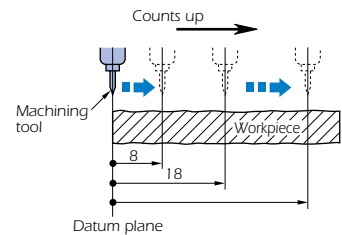
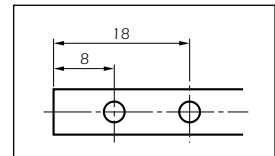

Bolt-hole circle machining

In milling, the drilling positions along the circumference of the base circle in the absolute zero approach mode can be easily displayed by entering the center coordinates, diameter, and number of divisions of the base circle.

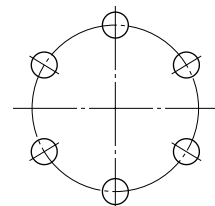



Touch-signal probe

The optional touch-signal probe makes it easy to perform such operations as datum point setting (detecting the workpiece edge and setting the counter display to zero), workpiece centering, and dimensional measurement (detecting the workpiece end point and holding the counter display).

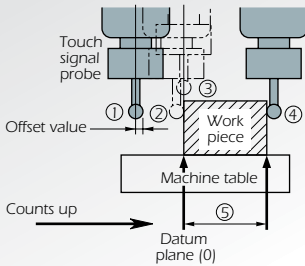

Scale reference point setting

The linear scale has scale reference points at 50mm intervals. When one of the points is detected, the linear scale issues a signal to hold/restart counting. If the distance from a scale reference point to the machine origin is registered as the offset value, it will be retained even when the power is off (hold function). When the power is turned on, the machine origin or machining datum can be easily recalled (set function).

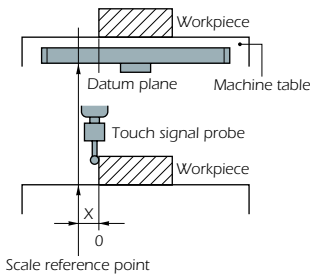

FOR SURFACE GRINDERS



Addition/subtraction

A value can be added to/subtracted from the display value by entering the value with the numeric keys.

FOR EDM



Maximum/minimum value hold

The counter's display values fluctuate in processes as electrical discharge machining, during which the electrode volume is increased or decreased. The maximum/minimum value hold function allows the counter to hold maximum or minimum values, thus allowing more precise controls of the machining position.

FOR LATHES



Diameter display

The doubled scale displacement can be displayed. This convenient feature can be used to display the diameter of a workpiece that results in a lathe cutting operation.

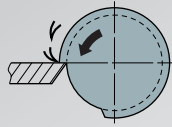

Addition of 2-scale data

The sum of the displayed values of two axes can be displayed. If a machine has two feed components, fine feed and coarse feed, each with its own scale, this function can be used to sum the two feed values.

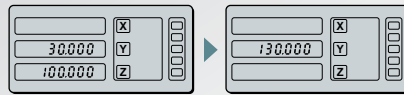

Direct data entry with Digimatic gage

A Mitutoyo SPC gage, such as the Digimatic Micrometer, Digimatic Caliper, etc., can be connected to the counter (requires an optional connecting cable). Measurement data from the gage does not require data conversion. This function can be used in conjunction with the diameter display function to greatly improve turning efficiency.

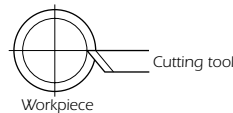

Coarse
machining

Machining a diameter of 12.340mm down to 10.050mm

Measuring

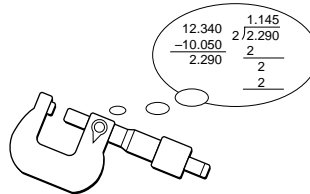

Fine
machining

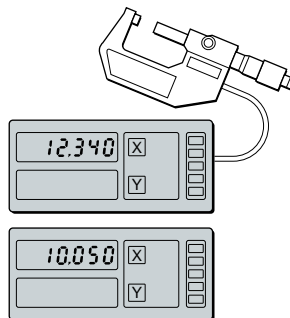

Cutting tool selection

Multiple absolute and incremental coordinates can be set for an axis. If individual cutting tools installed on a lathe are assigned dedicated coordinates, the tools can be used whenever necessary by simply selecting the tool, without resetting the machining datum point each time.

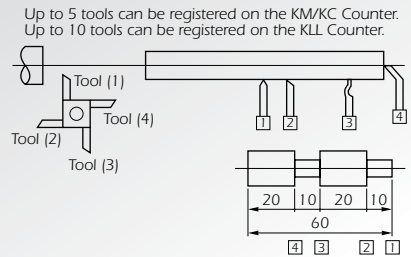

Coordinate data copy

Coordinates for cutting tools on a lathe can be set by copying the coordinate data (display values, datum points, and preset values) from one tool to another.

Conventional method

- (1) Measure the diameter (12.340mm).
- (2) Subtract the desired dimension from the measured value.
- (3) Halve the difference (2.290mm).
- (4) Feed the cutter by 1.145mm.

With KM/KC Counter

- (1) Diameter of 12.340mm is automatically preset. (Press the appropriate button on the counter or Digimatic micrometer.)
- (2) Feed the cutter until the counter displays the target dimension (10.050mm). (The diameter calculation function has been activated.)

Four groups of one-touch macro keys

For milling machine	For lathe (1)	For lathe (2)	For grinding machine
Switch absolute/incremental coordinate	Switch absolute/incremental coordinate	Switch absolute/incremental coordinate	Switch absolute/incremental coordinate
Select coordinates (0 to 5)	Select Tool 1	Select coordinates (0 to 5)	Select coordinates (0 to 5)
Zero approach machining [ABS mode]	Select Tool 2	Coordinate data transfer	Zero approach machining [ABS mode]
Bolt-hole circle machining	Select Tool 3	Zero approach machining [ABS mode]	Zero approach machining [INC mode]
Datum point setting with touch signal probe	Select Tool 4	Zero approach machining [INC mode]	Direct data entry with Digimatic gage
Centering with touch signal probe	Zero approach machining [ABS mode]	Direct data entry with Digimatic gage	1/2 calculation
Datum point registration using scale reference point	Zero approach machining [INC mode]	Datum point registration using scale reference point	Addition/subtraction
Datum point recall using scale reference point	Direct data entry with Digimatic gage	Datum point recall using scale reference point	Datum point recall using scale reference point

SPECIAL FUNCTIONS

MACRO One-touch macro keys

Eight frequently used functions are registered to the touch keys (called "one-touch macro keys"). Each of these functions can easily be executed at a single touch. Four groups of functions are provided for use with lathes, milling machines, grinding machines, etc. Only one of the groups, which should be selected so that it is suitable for application, is registered to one-touch operation keys at a time. The one-touch operation keys can be easily customized, by replacing unnecessary functions with others, so that the counter can be operated as effectively as possible.



The milling functions are registered to the one-touch macro keys of the KM/KC Counter prior to shipment.

PROG. Part-program setting

The part program setting function is convenient in such cases where multiple workpieces of the same type must be machined. Sequences of machining operations, including presetting, zero setting, zero approach, etc., can be registered and executed as necessary. Up to 9 sequences (programs) can be registered by specifying operations with keys or by recording operations during machining (which is called the "teaching function").

Programmable remote controller

The optional programmable remote controller (09CAA384) can be used to edit registered part programs by deleting or inserting machining operations.



09CAA384

ERROR COMPENSATION

Linearity error compensation

Machine errors caused due to workpiece weight, inaccurate table adjustment, etc., are linearly compensated to reduce the positioning error.

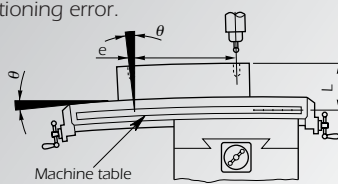

Pitch error compensation

The positioning error of a machine tool can be reduced by approximating the errors with a nine section graph. This function provides more accurate compensation than linearity error compensation.

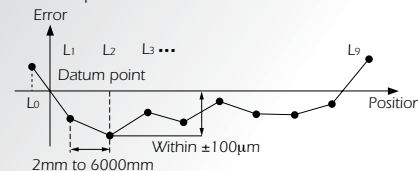

Lost motion compensation

This function compensates for the forward and backward positioning errors that occur when the table is fed.

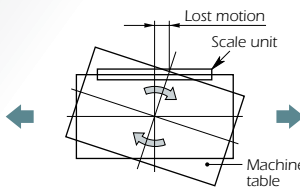

1234 Smoothing

Smoothing makes the display value easier to read when a minimum reading fluctuates due to machine vibration.

DATA OUTPUT

RS-232C
OUTPUT

RS-232C Interface Unit

The EIA standard RS-232C connector provides data transfer to/from a personal computer with an RS-232C Interface Unit. Not only can coordinate data be output from this connector, but it can also receive signals from the personal computer to perform zero setting, presetting, etc.



BCD
OUTPUT

BCD Code Out

Coordinate data can be converted into parallel BCD code and sent to the external printer, etc.



DIGIMATIC
OUTPUT

Digimatic Code Out Unit

The Digimatic Mini-processor DP-1HS can be connected for easy coordinate data printout.



GP-IB
OUTPUT

GP-IB Interface

Data can be transferred to/from an external device with a GP-IB Interface. Not only can coordinate data be output using this interface, but it can also be used to receive signals from an external device to perform zero setting, presetting, etc.



LIMIT
OUTPUT

Limit Signal Output

If tolerances or the upper and lower limits have been preset, the counter issues signals to turn on/off tolerancing lamps on the external device according to the scale movement. This function is useful when scale units are mounted on the measuring machine to perform GO/NG judgment on workpieces or dimensions.



KL Counter

- Zero-setting and 1/2 calculation of the displayed value can be performed by just a touch of a key.
- Preset value can be easily entered using the numeric keys.
- A power voltage ranging from 100V AC to 240V AC can be used. No switching between voltages is required.
- The machine origin and the reference point for machining can be easily reproduced, using the scale reference point signal.
- Can be connected to a personal computer by installing an RS-232C Interface Unit (optional).



Functions included

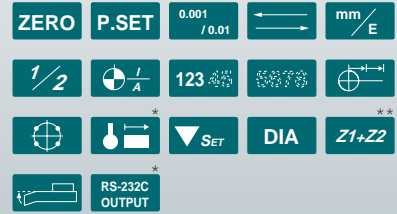

* Optional accessory
** Only available on the 3-axis type

Photo: 2-axis type

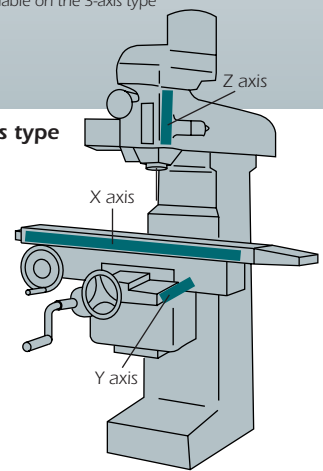

Standard Type with Ease of Use

Especially for Milling Machines

Dimensions

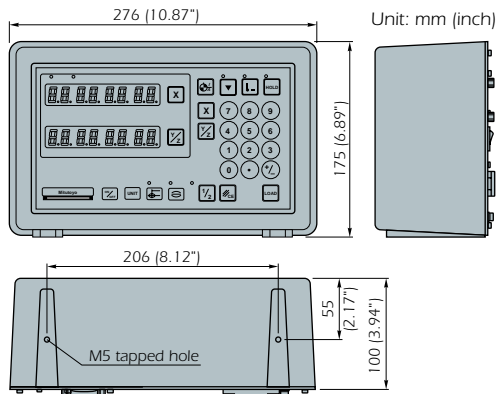

Optional accessories

- 09CAA954** RS-232C Interface Unit
- 938140** Touch-signal probe (shank dia.: 20mm)
- 935094** Touch-signal probe (shank dia.: 32mm)
- 902329** Touch-signal probe (shank dia.: 1/2")

SPECIFICATIONS

Model	KL Counter		
Type	mm/inch		
Number of scale inputs	1-axis	2-axis	3-axis
Order no.			
100V AC	174-161	174-163	174-165
120V AC	174-161A	174-163A	174-165A
230/220V AC	174-161D	174-163D	174-165D
240V AC (UK)	174-161E	174-163E	174-165E
240V AC (Australia)	174-161F	174-163F	174-165F
Resolution	0.001mm/0.005mm/0.01mm/.0001"/.0005"/.001"		
Maximum counting digits	7 digits (with a negative [-] sign and a floating decimal point)		
Display	LED (green)		
Maximum response speed	100kHz (The maximum response speed of each model of the AT100 Series linear scales acceptable.)		
Power consumption	Approx. 25VA (at maximum)		
Power supply	100-240V AC, 50/60Hz		
Operation temperature	0°C to 40°C		
Dimensions (WxDxH)	276x177x100mm (10.87"x6.97"x3.94")		
Mass	2.4kg (5.28 lbs.)		
Standard accessories	Power cord (2m), grounding lead wire (4m), dust cover, user's manual, warranty		

KLL Counter

- With its design based on the KL Counter, the KLL Counter is a dedicated lathe-machining counter with convenient functions.
- By the 2-scale data addition function, a total value of readings by the two scales is displayed as a displacement on the Z-axis; one scale is attached to the fine-feed table and the other to the coarse-feed table.
- Can store offset values of a maximum of 10 different kinds of tools in the memory. This eliminates tedious value inputs when changing tools.
- Can be connected to a personal computer by installing an RS-232C Interface Unit (optional).



Functions included

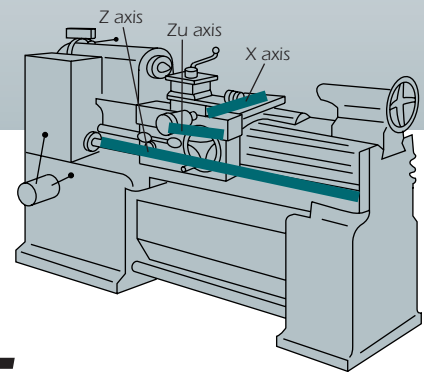
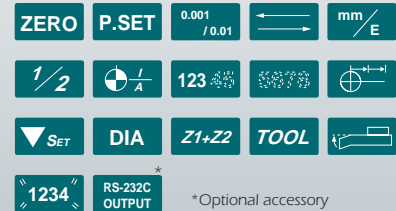

Special Version of KL Counter for Lathes

Dimensions

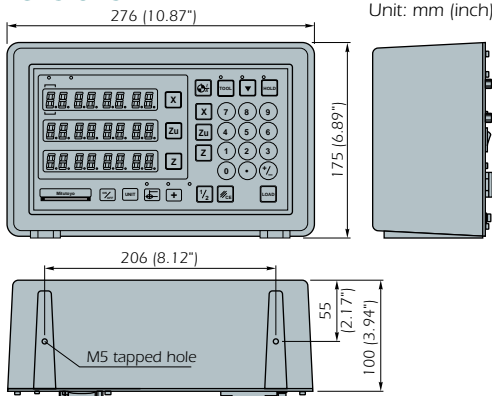

Optional accessory

09CAA954 RS-232C Interface Unit

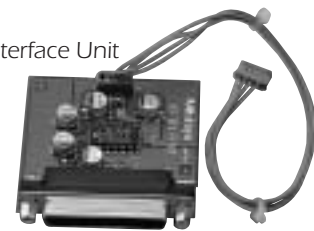

SPECIFICATIONS

Model	KLL Counter	
Type	mm/inch	
Number of scale inputs	3-axis	
Order no.	100V AC	174-167B
	120V AC	174-167A
(Each order number suffix denotes the AC power cord type included.)	230/220V AC	174-167D
	240V AC (UK)	174-167E
	240V AC (Australia)	174-167F
Resolution	X-axis	0.001mm/0.002mm/0.01mm/.0001"/.0002"/.001" (in DIA mode)
	Zu-axis, Z-axis	0.001mm/0.005mm/0.01mm/.0001"/.005"/.001" (in RAD mode)
Maximum counting digits	7 digits (with a negative [-] sign and a floating decimal point)	
Display	LED (green)	
Maximum response speed	100kHz (The maximum response speed of each model of the AT100 Series linear scales acceptable.)	
Power consumption	Approx. 25VA (at maximum)	
Power supply	100V-240V AC, 50/60Hz	
Operation temperature	0°C to 40°C	
Dimensions (WxDxH)	276x177x100mm (10.87"x6.97"x3.94")	
Mass	2.4kg (5.28 lbs.)	
Standard accessories	Power cord (2m), grounding lead wire (4m), dust cover, user's manual, warranty	

KM Counter[†]

- A multi-functional counter equipped with various functions convenient for various machine tools such as lathes, milling machines, and grinding machines.
- One-touch operation of various functions using the macro keys.
- Preset value can be easily entered using the numeric keys.

- The machine origin and the reference point for machining can be easily reproduced, using the scale reference point signal.
- The optional Zero-set Remote Controller allows wireless zero-setting.
- Measuring procedures can be stored in the memory, using the part program setting function.

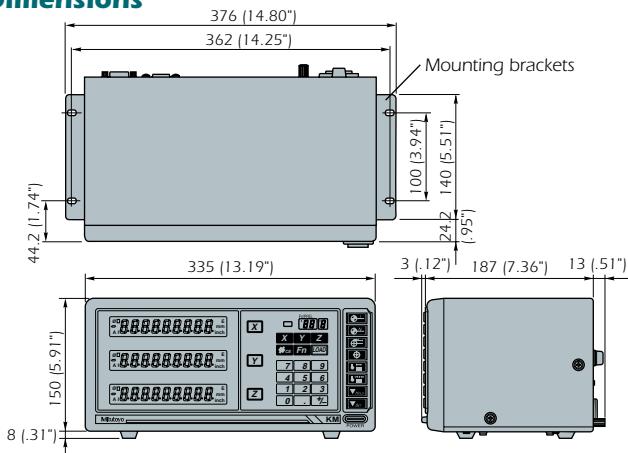

Photo: 2-axis type

Multi-function Type

Dimensions

Unit: mm (inch)



Functions included

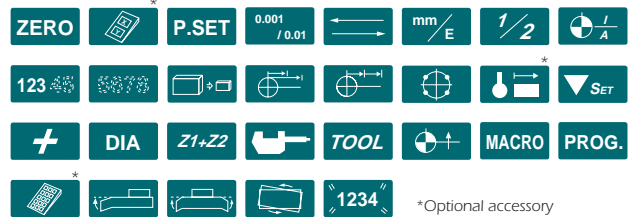

*Optional accessory

Optional accessories

- 09CAA335** Zero-set remote controller
- 09CAA384** Programmable remote controller
- 938140** Touch-signal probe (shank dia.: 20mm)
- 935094** Touch-signal probe (shank dia.: 32mm)
- 902329** Touch-signal probe (shank dia.: 1/2")

SPECIFICATIONS

Model	KM Counter						
	mm/E (=1/25.4mm)			mm/inch			
Type				1-axis	2-axis	3-axis	
Number of scale inputs				1-axis	2-axis	3-axis	
Order no.	100V AC	174-111	174-113	174-115	174-112	174-114	174-116
(Each order number suffix denotes the AC power cord type included.)	120V AC	174-111A	174-113A	174-115A	174-112A	174-114A	174-116A
	230/220V AC	174-111D	174-113D	174-115D	174-112D	174-114D	174-116D
	240V AC (UK)	174-111E	174-113E	174-115E	174-112E	174-114E	174-116E
	240V AC (Australia)	174-111F	174-113F	174-115F	174-112F	174-114F	174-116F
Resolution	0.0005mm/0.001mm/0.002mm/0.005mm/0.01mm			0.0005mm/0.001mm/0.002mm/0.005mm/0.01mm/0.0002"/0.0005"/0.001"/0.002"/0.005"/0.01"			
Maximum counting digits	8 digits (with a negative [-] sign and a floating decimal point)						
Display	Luminous fluorescence tube (green)						
Maximum response speed	100kHz (The maximum response speed of each model of the AT100 Series linear scales are acceptable.)						
Power consumption	Approx. 30VA (at maximum)						
Power supply	100-120V/200-240V AC, 50/60Hz						
Operation temperature	0°C to 40°C						
Dimensions (WxDxH)	335x187x158mm (13.19"x7.36"x6.22")						
Mass	3.3kg (7.26 lbs.)	3.4kg (7.48 lbs.)	3.5kg (7.7 lbs.)	3.3kg (7.26 lbs.)	3.4kg (7.48 lbs.)	3.5kg (7.7 lbs.)	
Standard accessories	User's manual, power cord (2m), grounding lead wire (4m), spare fuse, macro key labels, dust cover, mounting brackets (1 set), warranty						

[†]KM Counter is not available in the US market.

KC Counter

Equipped with similar functions to that of the KM Counter, the KC Counter is a multi-functional counter to which various interfacing units can be attached for data output.

Select an output specification from five types: RS-232C, GP-IB, BCD, Digimatic, and Limit Signal outputs.



Photo: 3-axis type

RS-232C/BCD/GP-IB/Digimatic/ Limit Signal Outputs Available.

Dimensions

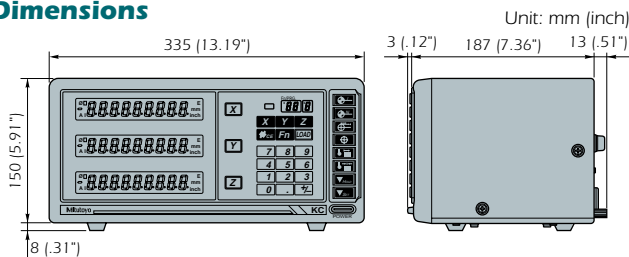

Functions included

* Optional accessory
** One of these Interfaces/Code Out Units can be installed (optional).

SPECIFICATIONS

Model	KC Counter					
	mm/E (=1/25.4mm)			mm/inch		
Type	1-axis	2-axis	3-axis	1-axis	2-axis	3-axis
Number of scale inputs	1-axis	2-axis	3-axis	1-axis	2-axis	3-axis
Order no.	174-121-11* ¹	174-123-11* ¹	174-125-11* ¹	174-122-11* ¹	174-124-11* ¹	174-126-11* ¹
(Each order number suffix denotes the AC power cord type included.)	100V AC	174-121-13* ²	174-123-13* ²	174-122-13* ²	174-124-13* ²	174-126-13* ²
		174-121-14* ³	174-123-14* ³	174-122-14* ³	174-124-14* ³	174-126-14* ³
		174-121-15* ⁴	174-123-15* ⁴	174-122-15* ⁴	174-124-15* ⁴	174-126-15* ⁴
		174-121-16* ⁵	174-123-16* ⁵	174-122-16* ⁵	174-124-16* ⁵	174-126-16* ⁵
	120V AC	174-121A* ⁶	174-123A* ⁶	174-125A* ⁶	174-122A* ⁶	174-124A* ⁶
230/220V AC	174-121D* ⁶	174-123D* ⁶	174-125D* ⁶	174-122D* ⁶	174-124D* ⁶	174-126D* ⁶
240V AC (UK)	174-121E* ⁶	174-123E* ⁶	174-125E* ⁶	174-122E* ⁶	174-124E* ⁶	174-126E* ⁶
240V AC (Australia)	174-121F* ⁶	174-123F* ⁶	174-125F* ⁶	174-122F* ⁶	174-124F* ⁶	174-126F* ⁶
Resolution	0.0005mm/0.001mm/0.002mm/0.005mm/0.01mm			0.0005mm/0.001mm/0.002mm/0.005mm/0.01mm/0.0002"/0.0005"/0.001"/0.002"/0.005"/.001"		
Maximum counting digits	8 digits (with a negative [-] sign and a floating decimal point)					
Display	Luminous fluorescence tube (green)					
Maximum response speed	100kHz (The maximum response speed of each model of the AT100 Series linear scales are acceptable.)					
Power consumption	Approx. 30VA (at maximum)					
Power supply	100-120V/200-240V AC, 50/60Hz					
Operation temperature	335x187x158mm (13.19"x7.36"x6.22")					
Dimensions (WxDxH)	0°C to 40°C					
Mass	3.5kg (7.7 lbs.)	3.6kg (7.92 lbs.)	3.7kg (8.14 lbs.)	3.5kg (7.7 lbs.)	3.6kg (7.92 lbs.)	3.7kg (8.14 lbs.)
Standard accessories	User's manual, power cord (2m), grounding lead wire (4m), spare fuse, macro key labels, dust cover, mounting bracket (1 set), warranty					

*¹ Provided with a parallel BCD Code Out Unit as standard
*² Provided with an RS-232C Interface Unit as standard

*³ Provided with a GP-IB Interface as standard
*⁴ Provided with a Digimatic Code Out Unit as standard

*⁵ Provided with a Limit Signal Output Unit as standard
*⁶ Data output unit is optional.

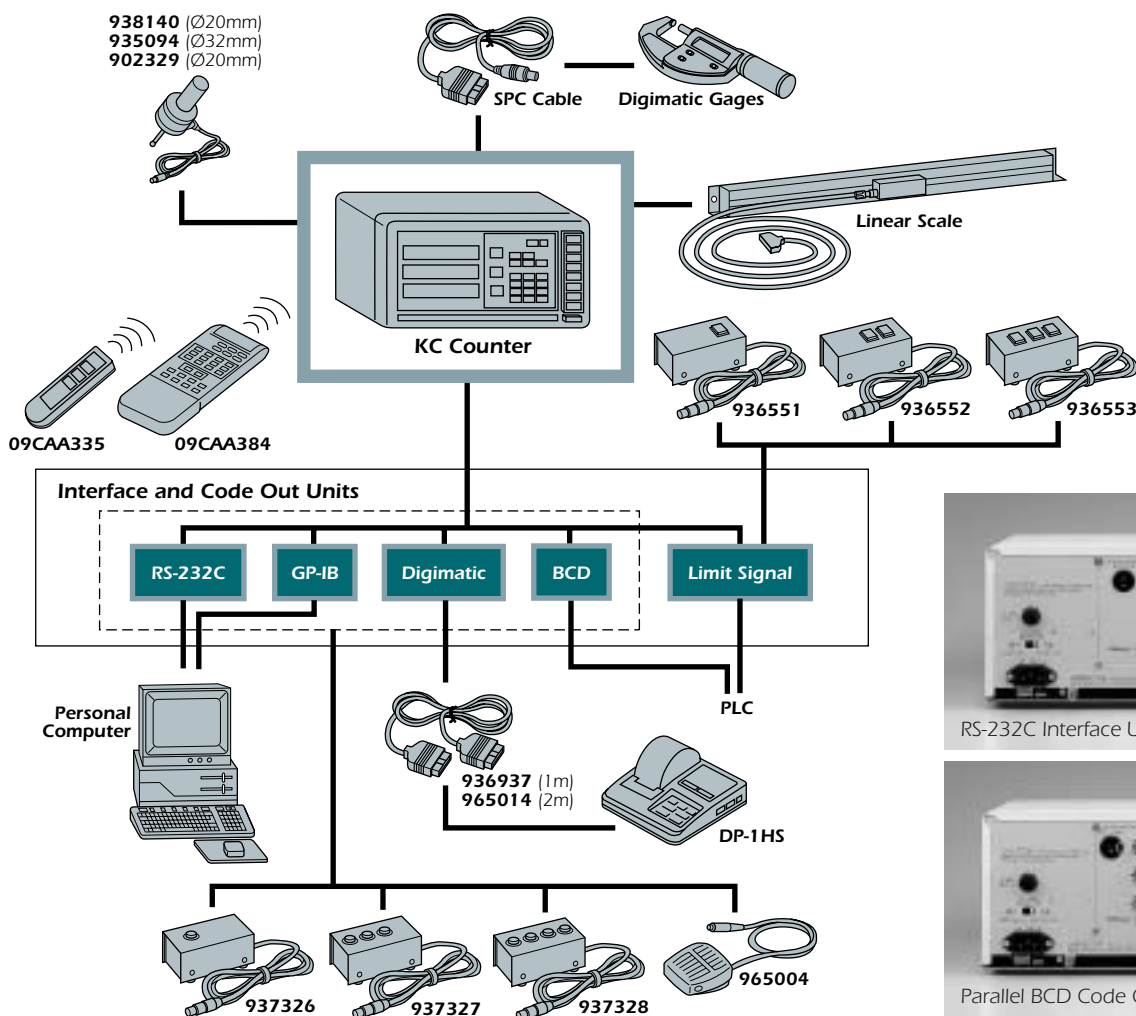

Optional accessories

- 09CAA335** Zero-set remote controller
- 09CAA384** Programmable remote controller
- 09CAA402** RS-232C Interface Unit
- 09CAA412** Parallel BCD Code Out Unit (1-axis)
- 09CAA424** Parallel BCD Code Out Unit (2-axis)
- 09CAA430** Parallel BCD Code Out Unit (3-axis)
- 09CAA462** Digimatic Code Out Unit
- 09CAA452** GP-IB Interface Unit
- 09CAA472** Limit Signal Output Unit
- 937326** External load box (1-axis)*
- 937327** External load box (2-axis)*
- 937328** External load box (3-axis)*
- 965004** External load foot switch (for all axes)*
- 936551** External zero-set box (1-axis)**
- 936552** External zero-set box (2-axis)**
- 936553** External zero-set box (3-axis)**
- 938140** Touch-signal probe (shank dia.: 20mm)
- 935094** Touch-signal probe (shank dia.: 32mm)
- 902329** Touch-signal probe (shank dia.: 1/2")
- 936937** SPC cable (1m) for connecting with DP-1HS***
- 965014** SPC cable (2m) for connecting with DP-1HS***
- 264-503** DP-1HS Digimatic Mini-processor (100V AC)***
- 264-503A** DP-1HS Digimatic Mini-processor (120V AC)***
- 264-503D** DP-1HS Digimatic Mini-processor (230V AC)***
- 264-503E** DP-1HS Digimatic Mini-processor (240V AC)***

*RS-232C Interface Unit, BCD Code Out Unit, Digimatic Code Out Unit, or GP-IB Interface Unit is required.

**Limit Signal Output Unit (09CAA472) is required.

***Digimatic Code Out Unit (09CAA462) is required.



RS-232C Interface Unit (09CAA402)



Parallel BCD Code Out Unit (09CAA430)



Digimatic Code Out Unit (09CAA462)



GP-IB Interface Unit (09CAA452)



Limit Signal Output Unit (09CAA472)

KS Counter

- A counter with basic functions. Suitable for reading displacement of measuring fixtures and an X-Y table.
- One-touch operation of Zero-setting and 1/2 calculation.

- Can be connected to a personal computer by installing an RS-232C Interface Unit. (1 or 2-axis type only.)



Functions included



*Optional accessory

Photo: 2-axis type

Basic Function Type for Measuring Equipment/ Surface Grinders



RS-232C Interface Unit (optional)

Optional accessories

- 09CAA335** Zero-set remote controller
- 09CAA762** RS-232C Interface Unit*
- 937326** External load box (1-axis)**
- 937327** External load box (2-axis)**
- 965004** External load foot switch (for all axes)**
- 936551** External zero-set box (1-axis)**
- 936552** External zero-set box (2-axis)**

*Only available on the 1 or 2-axis KS Counter.
RS-232C Interface Unit (09CAA762**) is required.

Dimensions

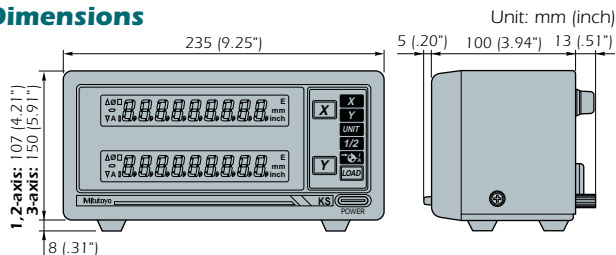

SPECIFICATIONS

Model	KS Counter					
	mm/E (=1/25.4mm)			mm/inch		
Type						
Number of scale inputs	1-axis	2-axis	3-axis	1-axis	2-axis	3-axis
Order no.	100V AC 174-101-1	120V AC 174-101-1A	230/220V AC 174-101-1D	240V AC (UK) 174-101-1E	240V AC (Australia) 174-101-1F	
(Each order number suffix denotes the AC power cord type included.)						
Resolution	0.0005mm/0.001mm/0.002mm/0.005mm			0.0005mm/0.001mm/0.002mm/0.005mm/ .00002"/.00005"/.0001"/.0002"/.0005"		
Maximum counting digits	8 digits (with a negative [-] sign and a floating decimal point)					
Display	Luminous fluorescence tube (green)					
Maximum response speed	100kHz (The maximum response speed of each model of the AT100 Series linear scales are acceptable.)					
Power consumption	Approx. 30VA (at maximum)					
Power supply	100-120V/200-240V AC, 50/60Hz					
Operation temperature	0°C to 40°C					
Dimensions (WxDxH)	235x100x115mm (9.25"x3.94"x4.53")	235x100x115mm (9.25"x3.94"x4.53")	235x100x158mm (9.25"x3.94"x6.22")	235x100x115mm (9.25"x3.94"x4.53")	235x100x115mm (9.25"x3.94"x4.53")	235x100x158mm (9.25"x3.94"x6.22")
Mass	1.9kg (4.18 lbs.)	2.0kg (4.18 lbs.)	2.2kg (4.84 lbs.)	1.9kg (4.18 lbs.)	2.0kg (4.18 lbs.)	2.2kg (4.84 lbs.)
Standard accessories	User's manual, power cord (2m), grounding lead wire (4m), spare fuse, dust cover, mounting bracket (1 set), warranty					

KLD Counter

- A 1-axis counter dedicated to sending signals when a linear scale displacement value and a preset limit value coincide.
- Three types of limit settings are available: 2 steps, 4 steps, and 8 steps.

- For controlling a vertical position of an EDM or a grinding machine.
- Can be connected to a personal computer or a sequencer by installing an RS-232C Interface Unit or a BCD Code Out unit. (Both interface units are optional accessories.)



Photo: 4-step limit setting type

Functions included

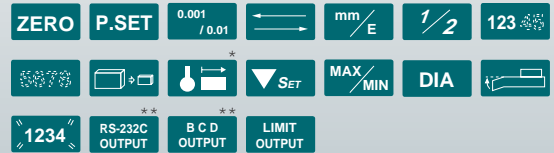

*Optional accessory

**Either of these units can be installed (optional).

With Limit Signal Outputs



Photo: 8-step limit setting type

Dimensions

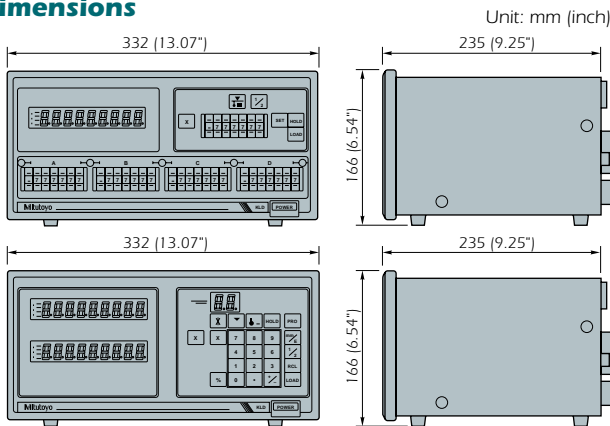

Optional accessories

- 907569** RS-232C Interface Unit
- 907570** BCD Code Out Unit
- 965004** External load foot switch*
- 937326** External load box*
- 936551** External zero-set box
- 938140** Touch-signal probe (shank dia.: 20mm)
- 935094** Touch-signal probe (shank dia.: 32mm)
- 902329** Touch-signal probe (shank dia.: 1/2")

*RS-232C Interface Unit (**907569**) is required.

SPECIFICATIONS

Model	KLD Counter		
Type	mm/inch		
Number of scale inputs	1-axis		
Limit signal output	2-step	4-step	8-step
Order no. (Each order number suffix denotes the AC power cord type included.)	100V AC	174-141	174-143
	120V AC	174-141A	174-143A
	230/220V AC	174-141D	174-143D
	240V AC	174-141E	174-143E
Resolution	0.0005mm/0.001mm/0.002mm/0.005mm/0.01mm/0.0002"/0.0005"/0.001"/0.002"/0.005"/0.01"		
Maximum counting digits	9 digits (with a negative [-] sign and a floating decimal point)		
Display	Luminous fluorescence tube (green)		
Limit value setting method	Digital switcho	Digital switcho	Ten-keyboard
Maximum response speed	50kHz (60m/min. with the AT100 Series linear scales)		
Power consumption	Approx. 20VA (at maximum)		
Power supply	100-120V/200-240V AC, 50/60Hz		
Operation temperature	0°C to 40°C		
Dimensions (WxDxH)	332x165.5x235mm (13.07"x6.52"x9.25")		
Mass	4.5kg [9.9 lbs.]		
Standard accessories	User's manual, power cord (2m), grounding lead wire (4m), spare fuse, warranty		

Connection with External Devices

System diagram

Mitutoyo's Linear Scales accurately detect and display the displacement of machine tools or measuring equipment, and output the measurement data to a peripheral device such as PC or Sequencer via an interface. A variety of interfaces are available for various outputs such as RS-232C, BCD, GP-IB, limit signal, and Digimatic outputs. Each output board is optional.

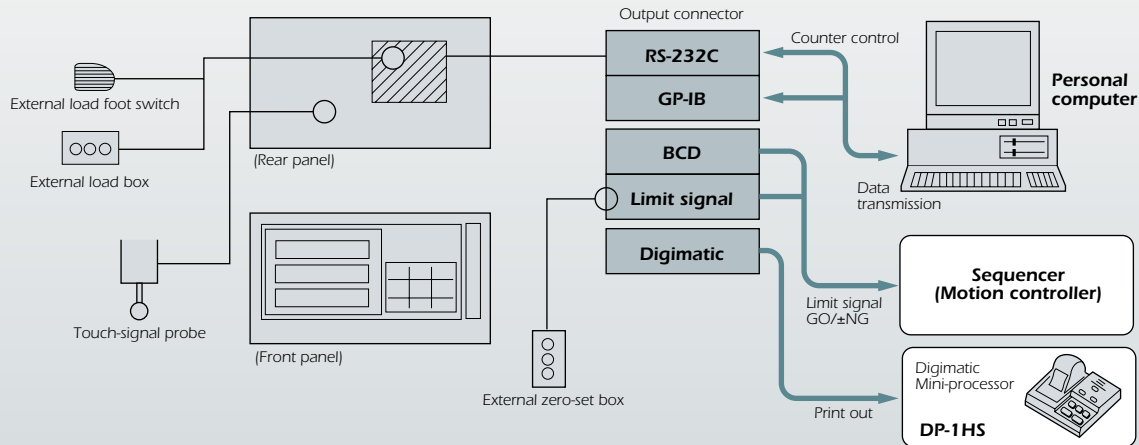

RS-232C Interface Unit

- The external load box, foot switch, or touch signal probe allows the measurement data in the RS-232C format from the RS-232C Interface Unit to be output to a peripheral device.
- The RS-232C Interface Unit enables measurement data output, as well as Zero-Setting, Preset, and Limit Setting of counter by commands from the computer.
- With the use of the RS-232C Interface Unit, the counter can be set to output measured data at a specified interval (Interval Mode).

[KL/KLL/KC/KS/KLD Counter]

Specifications

(1) Receptacle used

- D-Sub 25-pin (female)
- Threads specified in mm

Note) A connecting cable or connector is not included in the RS-232C Interface Unit.

(2) Applicable plug

- D-Sub 25-pin (male)
- Threads specified in mm

(3) Communication specifications (conforming with EIA RS-232C)

Home position	DCE (Use a straight cable to connect to a personal computer.)
Communication method	Half-duplex, nonprocedural
Data transfer speed (Baud rate)	150*, 300, 600, 1200, 2400, 4800, 9600, 19200*bsp
Bit configuration	Start bit: 1 Data bit: 7 or 8* (ASCII code, upper-case characters) Parity bit: 1 (even, odd), 0 (none) Stop bit: 1 or 2*
Communication conditions	Can be set using the respective parameters.

*KLD Counter only

(4) Pin assignment

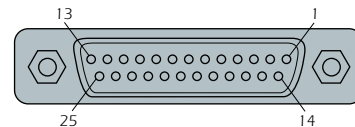

No. of pin	Signal	I/O	Remarks
1	FG	—	Frame grounding
2	TXD	Input	Data transfer
3	RXD	Output	Data reception
4**	RTS	Input	Data demand
5	CTS	Output	Communication grant
6	DSR	Output	Data set ready
7	S.G	—	Signal grounding
8***	CD	Output	Carrier detect
9 to 19	—	—	Not used
20**	DTR	Input	Data terminal ready
21 to 25	—	—	Not used

**Not used on KL Counter and KLL Counter

***KLD Counter only

Data and Commands

(1) Data format

When the counter displays "12345.678".

X		+	1	2	3	4	5	.	6	7	8	CR	LF
---	--	---	---	---	---	---	---	---	---	---	---	----	----

When the counter displays "0.000".

X		+	0	0	0	0	0	.	0	0	0	CR	LF
---	--	---	---	---	---	---	---	---	---	---	---	----	----

- The output data format is fixed to either 7 or 8 digits, without zero-suppression. (7 digits only for KL and KLL Counters.)
- If data is output from multiple axes, a comma <, > is used as a delimiter.
Example: X +12345.678, Y +90123.456 CR LF
- Data is output in the same unit that is used on the counter (mm or inch). However, the unit itself will not be output.
- When a touch signal probe is used with a KLD Counter, measurement data can be output only in the Hold Mode.

(2) Operation for data output

Counter display values can be output in the following ways. Be careful not to input more than one signal type simultaneously.

Trigger	Counter mode	Output axis	Applicable counters
Touch signal probe	Nonal mode	All axes	KL, KC, KLD
	HOLD mode	Specified axis only	
External load box	Nomal mode	Axes that are selected by the external load box	KC, KS, KLD
	HOLD mode	Axes that are specified for data hold and that are selected by the external load box	
Data request command:	X CR LF	X axis	KL, KLL, KC, KS, KLD
	Y CR LF	Y axis	
	Z CR LF	Z axis	
	A CR LF	All axes	
Interval output		All axes	KC

(3) Error code output

If a data output command is issued when the counter is in an error status, or when an incorrect command is issued, the counter outputs a corresponding error code signal.

(4) Other commands

The counter can be controlled externally by executing the following commands through a computer, etc. Command codes must be entered in upper-case characters.

Function	Axis	Command code from PC	Applicable counters
Zero-setting Sets the counter display values to zero.	X axis Y axis Z axis All axes	RX CR LF RY CR LF RZ CR LF RA CR LF	KL, KLL, KC, KLD*
Error cancelation Has the same effect as the CANCEL key on the counter.	—	CO CR LF	KL, KLL, KC, KLD*
Preset Presets the counter display with the specified value.	X axis Y axis Z axis	C1X+00000000 CR LF C1Y+01234567 CR LF C1Z+99999999 CR LF	KC, KLD*
Key code By inputting the corresponding code, the counter can be controlled in the same way that the front panel key does.	—	KC Counter: C6 00000 CR LF └ 5-digit key code KLD Counter: K 00000 CR LF └ 5-digit key code	KC, KLD

[KL/KLL Counter]

Timing chart

(1) Trigger Mode (Data output by signals from the touch signal probe)

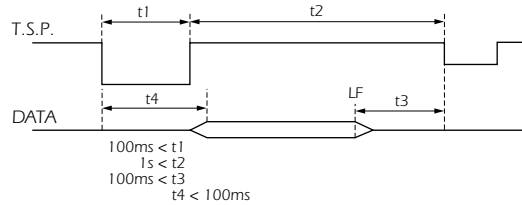

(2) Trigger Mode (Data output by commands from the computer)

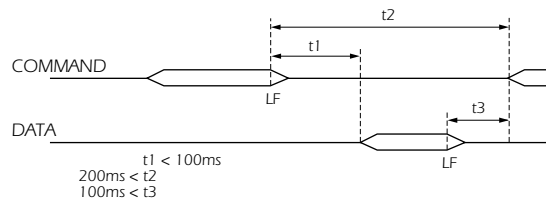

Note 1: Limits are set for t2 and t3 of KL and KLL Counters to describe accurate timing.
Note 2: KC and KS Counters hold counts at the same timing described above, also, to output count value data (X CR LF, etc.). The timing of a response to the Zero-setting command differs from the timing described above.

[KC/KS Counter]

Timing chart

(1) Interval Mode (Automatic data output at a specified interval)

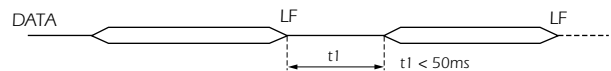

(2) Trigger Mode (Data output by a trigger signal from the touch signal probe or External Load Box)

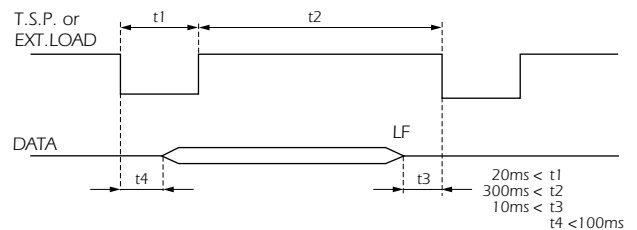

(3) Trigger Mode (Data output by commands from the computer)

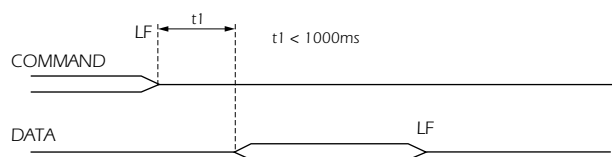

BCD Code Out Unit

The BCD Code Out Unit is an interface that performs conversion of measurement data to binary codes and the parallel output of these binary codes to an external device.

[KC Counter]

Connector

(1) Receptacle used

- Amphenol 36-pin (female) [57-40360-751 (DDK)]

(2) Applicable plug

- Amphenol 36-pin (male) [57-30360 (DDK) or equivalent]
- Note: The connecting plug is not provided.

(3) Pin assignment

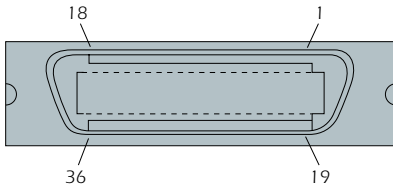

No. of pin	Signal	I/O
1	1x10 ⁰	Output
2	2x10 ⁰	Output
3	4x10 ⁰	Output
4	8x10 ⁰	Output
5	1x10 ¹	Output
6	2x10 ¹	Output
7	4x10 ¹	Output
8	8x10 ¹	Output
9	1x10 ²	Output
10	2x10 ²	Output
11	4x10 ²	Output
12	8x10 ²	Output
13	1x10 ³	Output
14	2x10 ³	Output
15	4x10 ³	Output
16	8x10 ³	Output
17	1x10 ⁴	Output
18	2x10 ⁴	Output

No. of pin	Signal	I/O
19	4x10 ⁴	Output
20	8x10 ⁴	Output
21	1x10 ⁵	Output
22	2x10 ⁵	Output
23	4x10 ⁵	Output
24	8x10 ⁵	Output
25	1x10 ⁶	Output
26	2x10 ⁶	Output
27	4x10 ⁶	Output
28	8x10 ⁶	Output
29	VALID	Output
30	COMMAND	Input
31	ACCEPT	Input
32	READY	Output
33	+5V*	Output
34	SIGN	Output
35	ALL-ZERO	Output
36	GND	Output

*Do not use this +5V current as an external power.

(4) I/O circuits

Input: Conforming to CMOS 54050

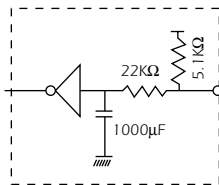

Output: Conforming to CMOS 74HC574

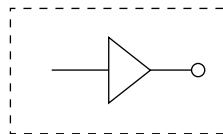

Operation

(1) Output of display values in the Interval Mode

At the predetermined intervals counter display values will be output to the external device.

(2) Output of display values in the Trigger Mode

Trigger	Counter mode	Output axis
Touch signal probe	Normal mode	All axes
	HOLD mode	Specified axis only
COMMAND signal from sequencer or external load box	Normal mode	Axes that correspond to the command signal or that are specified by the ext. load box.
	HOLD mode	Axes that are specified for data hold and that are selected by the command signal or the ext. load box.

Timing chart

(1) Interval Mode (Automatic data output at a specified interval)

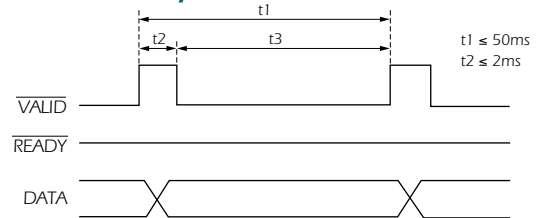

- Since the parallel data output is latched while $\overline{\text{VALID}}$ is in the LOW state, the data should be received during this interval ($t3$).
- The parallel data output remains latched at the rise or fall of $\overline{\text{VALID}}$. However, $\overline{\text{READY}}$ does not fall and remains at the HIGH state.

(2) Trigger Mode (Data output by a COMMAND signal input, trigger signal from the touch signal probe, or signal from External Load Box)

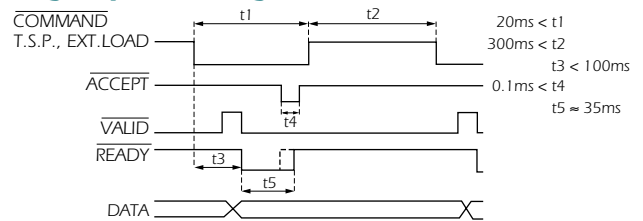

- If a $\overline{\text{COMMAND}}$ signal or a TSP (touch-signal probe) signal is input and $t3$ for readying data output has elapsed, $\overline{\text{READY}}$ output will remain LOW for a time interval of $t5$.
- It is also possible to receive data at a timing $\overline{\text{VALID}}$ falls.
- Input of an $\overline{\text{ACCEPT}}$ signal cancels the $\overline{\text{READY}}$ state within 35ms.

Note: Interval mode or trigger mode can be selected with the parameter setting (KC Counter).

Method of error output

(1) Error code output

If an error occurs in the error code output mode, the most significant 5 digits of the BCD output (Pin 9 to 24) and the sign (Pin 34) will be set to the HIGH state. Also, the error code will be output using the least significant 2 digits.

(2) High impedance state

If an error occurs in the high impedance mode, the output lines of all the BCD output digits (Pin 1 to 28) and the sign (Pin 34) will be set to the high impedance state.

(3) All-zero output

If an error occurs in the all-zero output mode, all the BCD output digits (Pin 1 to 28) will be set to the LOW state.

Note: The selection of error output modes can be set with the parameter setting (KC Counter).

[KLD Counter]

BCD-OUT connector

(1) Receptacle used

- Amphenol 36-pin (female) [57-40360-D39 (DDK)]

(2) Applicable plug

- Amphenol 36-pin (male) [57-30360-D39 (DDK) or equivalent]

Note: The connecting plug is not provided.

(3) Pin assignment

Note: The matching connector plug is not provided.

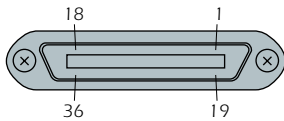

Pin	BCD Signal	I/O	Pin	BCD Signal	I/O	Pin	BCD Signal	I/O
1	1x10 ⁰	Out	13	1x10 ³	Out	25	1x10 ⁶	Out
2	2x10 ⁰	Out	14	2x10 ³	Out	26	2x10 ⁶	Out
3	4x10 ⁰	Out	15	4x10 ³	Out	27	4x10 ⁶	Out
4	8x10 ⁰	Out	16	8x10 ³	Out	28	8x10 ⁶	Out
5	1x10 ¹	Out	17	1x10 ⁴	Out	29	VALID	Out
6	2x10 ¹	Out	18	2x10 ⁴	Out	30	COMMAND	In
7	4x10 ¹	Out	19	4x10 ⁴	Out	31	ACCEPT	In
8	8x10 ¹	Out	20	8x10 ⁴	Out	32	READY	Out
9	1x10 ²	Out	21	1x10 ⁵	Out	33	+5V*1	Out
10	2x10 ²	Out	22	2x10 ⁵	Out	34	SIGN	Out
11	4x10 ²	Out	23	4x10 ⁵	Out	35	ALL-ZERO	Out
12	8x10 ²	Out	24	8x10 ⁵	Out	36	GND	Out

*1: Do not use this +5V current as an external power.

*2: The selection of the BCD signal or BIN signal can be set with the DIP switches on the codeout unit.

(4) Electric specification

Pin	Signal	Specifications
1 - 28	BCD code	CMOS 74HC373 output, positive logic
29	VALID	TLP 521 (photo-coupler) output, negative logic
30	COMMAND	CMOS 74HC14 input, negative logic
31	ACCEPT	CMOS 74HC14 input, negative logic
32	READY	TLP 521 (photo-coupler) output, negative logic
34	SIGN	CMOS 74HC373 output, HIGH level for "+"
35	ALL-ZERO	TLP 521 (photo-coupler) output, HIGH level for "all zero"

READY connector

(1) Receptacle used

Female [RM-12BRD-4S (Hirose)]

(2) Applicable plug

Male [RM-12BPG-4P (Hirose)]

Note: The connecting plug is not provided.

(3) Pin assignment

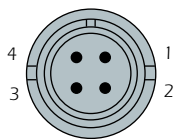

No. of pin	Signal
1	GND
2	READY
3	VALID
4	GND

- READY and VALID of the READY connector are connected to pins No.32 and No.29 of the BCD OUTPUT connector, respectively.

Timing chart

(1) Hold Mode (When using a touch probe signal or COMMAND signal input)

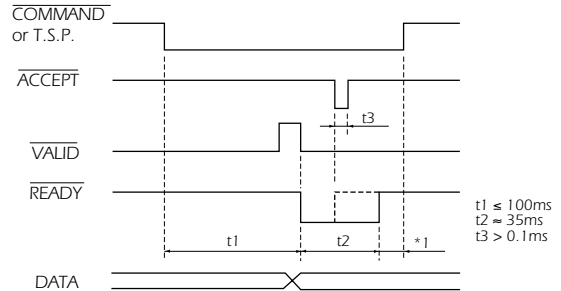

- If a COMMAND signal or a TSP signal is input and t1 for readying data output has elapsed, READY output will remain LOW for a time interval of t2. Since the data output is latched while READY is in the LOW state, the data should be received during this interval (t2). Input of an ACCEPT signal cancels the READY state within 35ms. It is also possible to receive data at a timing VALID falls.
- Display is on hold and output data are latched while a COMMAND signal or a touch signal is being input. When the data logging time is t2 or longer, input data during (t2)+(*1). If an error occurs, however, data is output according to the output format.

(2) Data Mode (When not using a touch signal or COMMAND signal input)

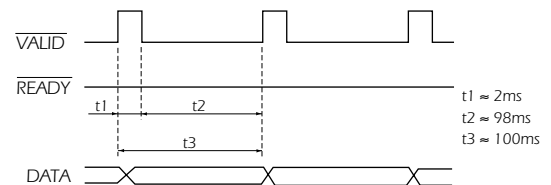

- Since the data output is latched while VALID is in the LOW state, the data should be received during this interval (t2).
- The data output remains latched at the rise or fall of VALID. However, READY does not fall and remains at the HIGH state.

Method of error output

(1) Error code output

If an error occurs in the error code output mode, the most significant 5 digits of the BCD output (Pin 9 to 24) and the sign (Pin 34) will be set to the HIGH state. Also, the error code will be output using the least significant 2 digits.

(2) High impedance state

If an error occurs in the high impedance mode, the output lines of all the BCD output digits (Pin 1 to 28) and the sign (Pin 34) will be set to the high impedance state.

(3) All-zero output

If an error occurs in the all-zero output mode, all the BCD output digits (Pin 1 to 28) will be set to the LOW state.

Note: The selection of error output modes can be set with the DIP switches on the counter.

GP-IB Interface

With the use of the GP-IB Interface, a maximum of 15 counters can be connected within one system. It is a standard interface that facilitates construction of a measuring system.

[KC Counter]

Pin assignment

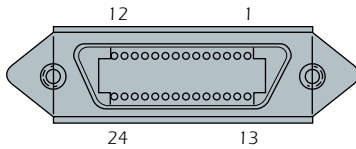

Note: The matching connector plug and cable are not provided.

No. of pin	Signal	No. of pin	Signal
1	DI01	19	DI05
2	DI02	20	DI06
3	DI03	21	DI07
4	DI04	22	DI08
5	EOI	23	REN
6	DAV	24	GND
7	NRFD	25	GND
8	NDAC	26	GND
9	IFC	27	GND
10	SRQ	28	GND
11	ATN	29	GND
12	Sealed	30	GND

Specifications

(1) Subset of GP-IB

- SH1: Source handshake
- AH1: Acceptor handshake
- T5: Talker (without a secondary readdress)
- L4: Listener (without a secondary readdress and listen only mode)
- SR1: Service request
- RL0: Does not use Remote local function.
- DC1: Device clear
- DT1: Device trigger
- C0: Does not use Controller function.
- PP0: Does not use Parallel poll function.

(2) Occurrence of SRQ

An SRQ interruption occurs in the following conditions:

- When an external trigger signal is issued by a touch signal probe or by an external load box.
- When the counter displays an error code

SRQ status byte

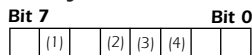

- 1: When SRQ has occurred
0: When SRQ has not occurred
- 2: 1: When data is latched by an external trigger signal
0: When a serial poll or IFC has been received
- 3: 1: Normal count
0: When a serial poll or IFC has been received
- 4: 1: When an error has occurred
0: When a serial poll or IFC has been received

(3) Others

The following specifications follow the RS-232C Interface Unit (for KC Counter) specifications:

- Data format
- Operation for data output
- Error code output
- Other commands

Timing chart

(1) Interval Mode (Talk Only*)

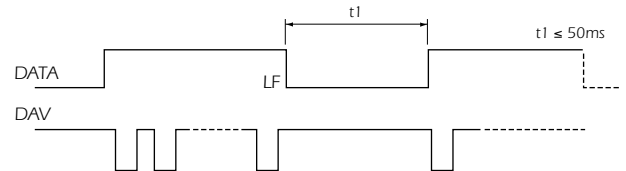

(2) Interval Mode (Normal Command*)

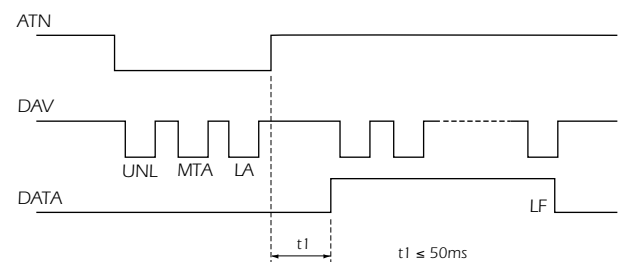

*Both "Talk Only" and "Normal Command" are methods to export data from the Interface. "Talk Only" simply export data without any control, while "Normal Command" controls communications (protocols.)

(3) Trigger Mode (Data output by a command from the personal computer)

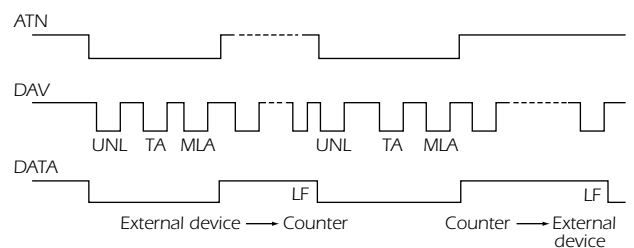

(4) Trigger Mode (Data output by a trigger signal from the touch signal probe or External Load Box)

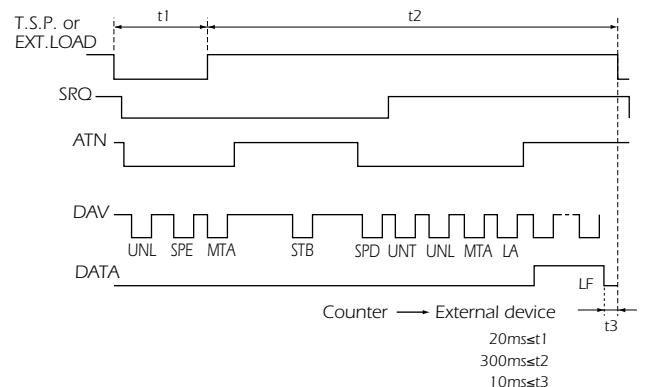

20ms ≤ t1
300ms ≤ t2
10ms ≤ t3

Limit Signal Output

An interface that outputs signals to an external device when the measurement value of the Linear Scale is the same as the preset limit value. Can be used for a GO/NG judgment and for an automatic control of a machine tool.

[KLD Counter]

Relay signal output connector (OUT-A)

This connector is used for outputting the relay signals. The limit signals will be output in the format of the relay's ON and OFF signals.

(1) Receptacle used

- MR-60RM (female) [Manufacturer: Honda Tsushin]

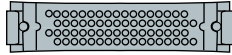

- When an error message is displayed, the alarm output will be set to ON. When this happens all relay outputs are set to ON.
- Limit signals numbered as many as the number of limit steps are existing, each uses a corresponding set of pins; 2-step type has up to limit signal 2, 4-step type has up to limit signal 4, 8-step type has up to limit signal 8. The other pins are not assigned.

Note: A connector plug (MR-60LF, Honda Tsushin) is provided as standard.

(2) Pin assignment (Example of a counter with 8 limit steps)

No. of pin	Signal
1 - 3	Coincidence: 1= a contact, 2= common, 3= b contact
4 - 6	Alarm: 4= a contact, 5= common, 6= b contact
7 - 9	Limit signal 0: 7= a contact, 8= common, 9= b contact
10 - 12	Limit signal 1: 10= a contact, 11= common, 12= b contact
13 - 15	Limit signal 2: 13= a contact, 14= common, 15= b contact
16 - 18	Limit signal 3: 16= a contact, 17= common, 18= b contact
19 - 21	Limit signal 4: 19= a contact, 20= common, 21= b contact
22 - 24	Limit signal 5: 22= a contact, 23= common, 24= b contact
25 - 27	Limit signal 6: 25= a contact, 26= common, 27= b contact
28 - 30	Limit signal 7: 28= a contact, 29= common, 30= b contact
31 - 33	Limit signal 8: 31= a contact, 32= common, 33= b contact
34 - 60	Not connected

Notes on the connection of relay signal output

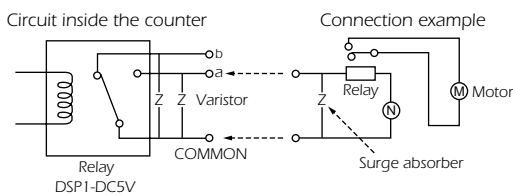

Do not use the limit signal output through the relay of the KLD Counter to directly control other devices such as motors. Always route the relay output through another relay at the external device side, as shown in the diagram above. Although the relay contact circuit of the counter has varistors (threshold voltage: 300V), provide a surge absorber on the external device to be connected, which may generate surge current. For example, a varistor is recommended for an AC circuit, and an appropriate diode is recommended for a DC circuit.

Capacity of relay contact inside the counter

5V - 30V AC, 10mA - 500mA
5V - 30V DC, 10mA - 500mA

Select an external control device which does not exceed the contact capacity described above.

Photocoupler signal output connector (OUT-B)

This connector is used for outputting the photocoupler signals, which use the same logic as the relay signals.

(1) Receptacle used

- MR-50RM (female) [Manufacturer: Honda Tsushin]

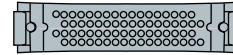

- When an error occurs, the alarm output will be set to ON.

Note: A connector plug (MR-50LF, Honda Tsushin) is provided as standard.

(2) Pin assignment (Example of a counter with 8 limit steps)

No. of pin	Signal
1 - 2	Limit signal 0: 1= emitter, 2= collector
3 - 4	Limit signal 1: 3= emitter, 4= collector
5 - 6	Limit signal 2: 5= emitter, 6= collector
7 - 8	Limit signal 3: 7= emitter, 8= collector
9 - 10	Limit signal 4: 9= emitter, 10= collector
11 - 12	Limit signal 5: 11= emitter, 12= collector
13 - 14	Limit signal 6: 13= emitter, 14= collector
15 - 16	Limit signal 7: 15= emitter, 16= collector
17 - 18	Limit signal 8: 17= emitter, 18= collector
19 - 46	Not connected
47 - 48	Coincidence: 47= emitter, 48= collector
49 - 50	Alarm: 49= emitter, 50= collector

Notes on the connection of photocoupler output

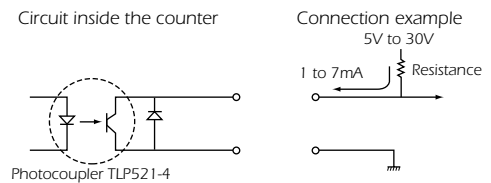

Recommended power supply to the transistor
5V - 30V, 1mA - 7mA

[KC Counter]

Pin assignment

(1) Receptacle used

- MR-50RMD2 (female) [Manufacturer: Honda Tsushin]

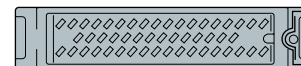

Note: A connector plug (MR-50M, Honda Tsushin) and case (MR-50LW, Honda Tsushin) are provided with the Limit Signal Output Unit.

(2) Pin assignment

No. of pin	Signal
1 - 2	Limit signal 0: 1= collector, 2= emitter
3 - 4	Limit signal 1: 3= collector, 4= emitter
5 - 6	Limit signal 2: 5= collector, 6= emitter
7 - 8	Limit signal 3: 7= collector, 8= emitter
9 - 10	Limit signal 4: 9= collector, 10= emitter
11 - 48	Not connected
49 - 50	Alarm: 49= collector, 50= emitter

Digimatic Code Out Unit

By connecting the Digimatic Code Out Unit to Mitutoyo's Mini-processor DP-1HS, measurement data can be printed out easily.

[KC Counter]

Pin assignment

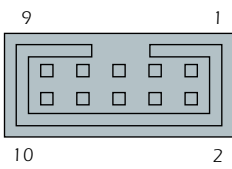

No. of pin	Signal	I/O
1	GND	—
2	DATA	Output
3	CK	Output
4	RD	Output
5	REQ	Input
6 - 9	Not connected	—
10	GND	—

Data output format

- Digimatic data format consists of counting data of 13 hexadecimal digits (d1 to d13), each of which consists of 4 bits and is output serially, starting from the LSB (2^0) of d1 to the MSB (2^3) of d13.
- When an error occurs, "E" will be output for all the digits of d1 to d13.

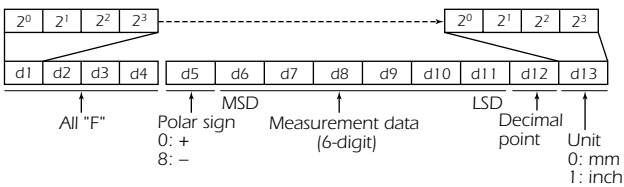

External load

Data on a desired axis or on all axes can be output to an external device by connecting the External Load Box to the KC Counter via an RS-232C Interface Unit, BCD Code Out Unit, GP-IB Interface Unit or Digimatic Code Out Unit.

(1) Pin assignment

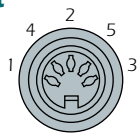

Applicable plug:
5-pin DIN connector

No. of pin	Signal
1	XLOAD
2	YLOAD
3	GND
4	ZLOAD
5	ALL LOAD

(2) Inner circuit of External Load Box

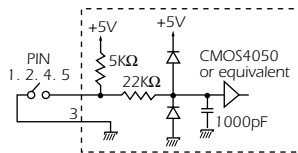

Timing chart

(1) Interval Mode

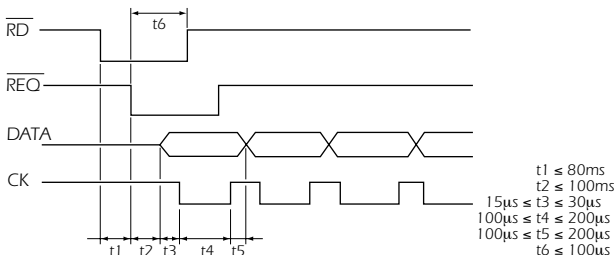

If an REQ signal is not input within 130ms after an RD signal, this interface continues to alternate between HIGH and LOW status of RD line at 150ms intervals, until an REQ signal is input.

(2) 2-axis or 3-axis output

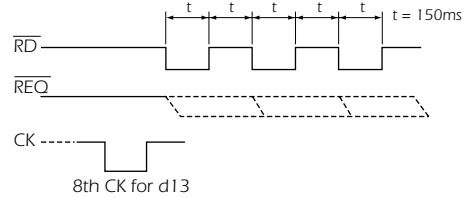

After the output of 8th clock for d13, this interface continues to alternate between HIGH and LOW status of RD line at 150ms intervals, until an REQ signal is input (Timeout is set to 2s.)

(3) Input timing of a touch signal or External Load signal

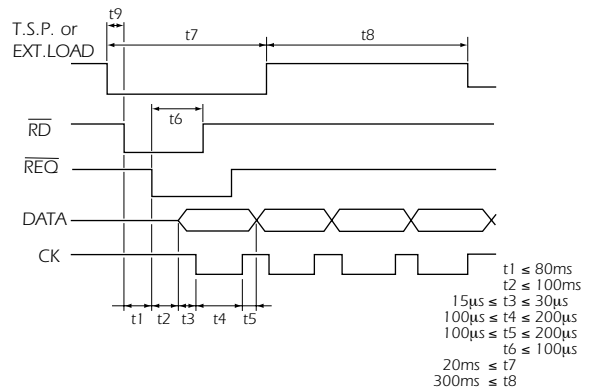

Digimatic Mini-processor DP-1HS

- 264-503** (w/100V AC adapter)
- 264-503A** (w/120V AC adapter)
- 264-503D** (w/220V AC adapter)
- 264-503E** (w/220-240V AC adapter)



- When the DP-1HS is used with a two-axis or three-axis counter, pressing the DATA key on the DP-1HS will print out data of all axes. When a data printout of a specific axis is desired, input the data with the External Load Box (optional accessory) after specifying the axis for the data output.
- When connected to a KC Counter, the DP-1HS cannot perform a statistical data processing.
- When connected to a KC Counter, only the last six digits of the value displayed on the counter are printed out.

Optional accessories

- 936937** Connecting cable (1m)
- 965014** Connecting cable (2m)
- 965465** RS-232C cable for data output

AT100 Series Scale Units

AT115

Type: Slim spar
MIN range: 100mm (4")
MAX range: 1,500mm (60")

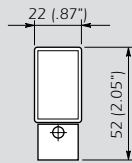

AT102

Type: Standard-size spar
MIN range: 100mm (4")
MAX range: 6,000mm (240")

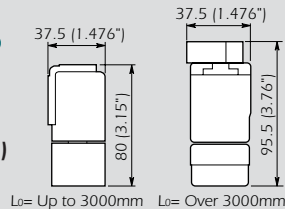

AT111

Type: Slim spar
MIN range: 100mm (4")
MAX range: 1,500mm (60")

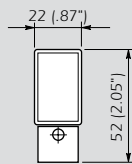

AT112

Type: Super slim spar
MIN range: 50mm (4")
MAX range: 1,020mm (40")

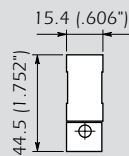

AT181

Type: Plunger
MIN range: 100mm (4")
MAX range: 600mm (24")

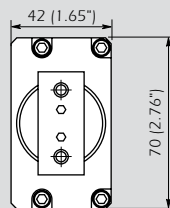

FEATURES

1. Low-priced model AT115

The low-priced version of Mitutoyo Linear Scale AT115 series are available. The mounting dimensions of all the AT115 models are the same as those of the AT111 series. Most suitable for mounting on a milling machine or an XY table.

2. Joint Structure of Detector

The ball joint structure is employed at the joint of the detector head and the slider (sensor unit) inside the scale. This structure prevents the slider movement from deviating from the normal moving directions when the detector head shifts to right and left, thus providing a normal scale reading and increasing flexibility in the scale installation. In addition, this structure is highly rigid and therefore has an excellent durability.

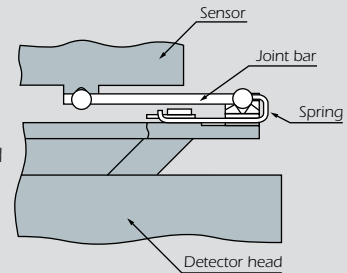

3. Water-proof Connector

A waterproof/splash-proof connector is used to enable separation of the signal cable. Thus, an installation and maintenance of the Linear Scale can be easily performed. (The signal cable in AT115 cannot be separated.)

4. Conduit armored type signal cable

The signal cable is protected by the conduit system. Its exterior is made of stainless steel, which is free from rust and corrosion and withstands sustained use for many hours.

5. Unique rubber-lip openings

The rubber-lip openings are shaped like the bottom of a ship that plows the water.

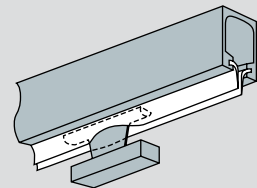

6. Excellent splash- and dust-proof rubber lip structure

The rubber lips are made of a strong, special urethane, and wires are inserted in these lips to improve the splash-proofing and dust-proofing of the scale (AT102 only).

APPLICATIONS

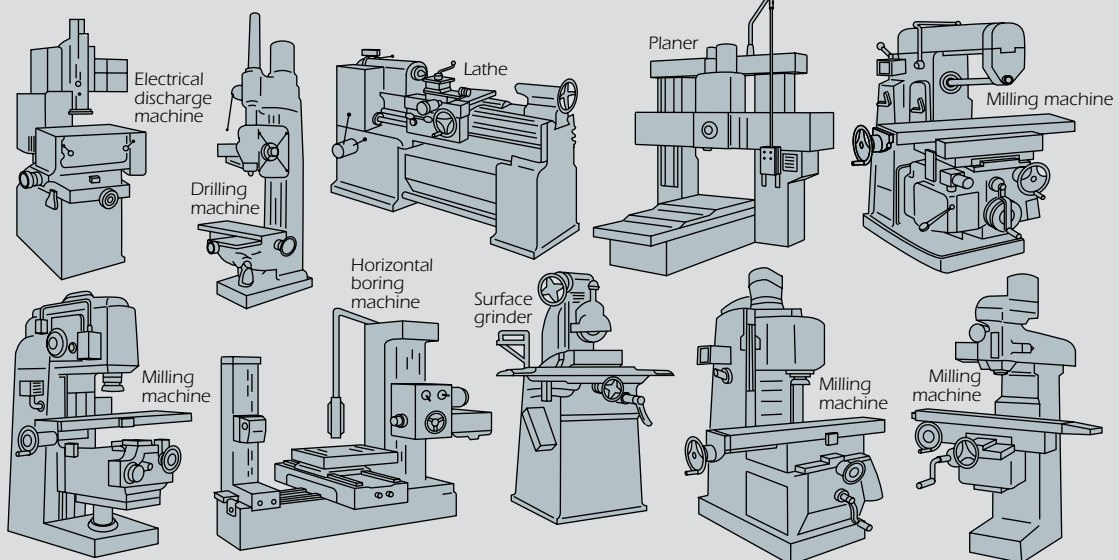

ORDER NUMBERS & SPECIFICATIONS OF SCALE UNITS

SPECIFICATIONS

Model	AT115/AT102/AT111/AT112	AT181
Detecting method	Photoelectric (transparent linear encoder)	
Light source	LED	
Receptor	Phototransistor	Photodiode
Output wave form	2-phase sine curves with a phase difference of 90°	
Scale grating pitch	20μm	
Resolution	0.0005mm - 0.01mm (depending upon the counter connected)	
Scale reference point	At every 50mm interval	Not provided
Coefficient of linear expansion	$(8 \pm 1) \cdot 10^{-6}/^{\circ}\text{C}$	
Power supply	5V±5% DC	
Current consumption	70mA at maximum	120mA at maximum
Sliding force	5N or less	6N or less
Dust/water protection	Conforming to IP-53	Conforming to IP-54
Operating temperature	0°C to 45°C	
Storage temperature	-20°C to 70°C	
Relative humidity	20% to 80% (no condensation)	

Spar type	Slim
Model	AT115
Accuracy at 20°C (μm)	STANDARD
Lo: Effective range	5+5Lo/1000
Maximum response speed	50m/min. (164ft/min.)

Order no. depending on Lo

100mm (4")	539-271
150mm (6")	539-272
200mm (8")	539-273
250mm (10")	539-274
300mm (12")	539-275
350mm (14")	539-276
400mm (16")	539-277
450mm (18")	539-278
500mm (20")	539-279
600mm (24")	539-281
700mm (28")	539-283
750mm (30")	539-284
800mm (32")	539-285
900mm (36")	539-286
1000mm (40")	539-287
1100mm (44")	539-288
1200mm (48")	539-289
1300mm (52")	539-290
1400mm (56")	539-291
1500mm (60")	539-292
1600mm (64")	
1700mm (68")	
1800mm (72")	
2000mm (80")	
2200mm (88")	
2400mm (96")	
2500mm (100")	
2600mm (104")	
2800mm (112")	
3000mm (120")	
3250mm (130")	
3500mm (140")	
3750mm (150")	
4000mm (160")	
4250mm (170")	
4500mm (180")	
4750mm (190")	
5000mm (200")	
5250mm (210")	
5500mm (220")	
5750mm (230")	
6000mm (240")	

Detecting principle

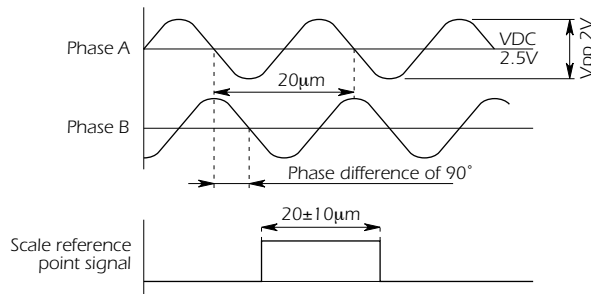
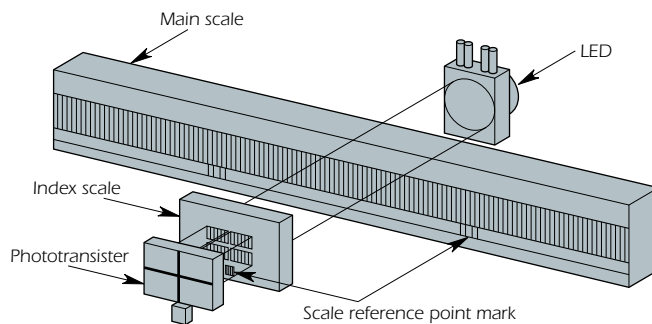

The detector of each scale unit consists of a light source (LED) and a photoelectric device (phototransistor) which face each other with the main scale and index scale between them. When the main scale moves, relative to the index scale, the quantity of light that is transmitted through the gratings on the index scale varies with the same period as the grating pitch. This variation of light intensity is converted into electrical signals and output as two-phase (A and B) waves with a phase difference of 90°. The display unit divides these signals to determine the direction of the scale movement, and digitally displays the displacement of the scale.

Standard-size		Extra-long	Slim	
AT102		AT102	AT111	
STANDARD	HIGH-ACCURACY	STANDARD	STANDARD	HIGH-ACCURACY
5+5L ₀ /1000	3+3L ₀ /1000	5+8L ₀ /1000	5+5L ₀ /1000	3+3L ₀ /1000
72m/min. (236ft/min.)	72m/min. (236ft/min.)	50m/min. (164ft/min.)	72m/min. (236ft/min.)	72m/min. (236ft/min.)
539-111	539-111-10		539-201	539-201-10
539-112	539-112-10		539-202	539-202-10
539-113	539-113-10		539-203	539-203-10
539-114	539-114-10		539-204	539-204-10
539-115	539-115-10		539-205	539-205-10
539-116	539-116-10		539-206	539-206-10
539-117	539-117-10		539-207	539-207-10
539-118	539-118-10		539-208	539-208-10
539-119	539-119-10		539-209	539-209-10
539-121	539-121-10		539-211	539-211-10
539-123	539-123-10		539-213	539-213-10
539-124	539-124-10		539-214	539-214-10
539-125	539-125-10		539-215	539-215-10
539-126	539-126-10		539-216	539-216-10
539-127	539-127-10		539-217	539-217-10
539-128	539-128-10		539-218	539-218-10
539-129	539-129-10		539-219	539-219-10
539-130	539-130-10		539-220	539-220-10
539-131	539-131-10		539-221	539-221-10
539-132	539-132-10		539-222	539-222-10
539-133	539-133-10			
539-134	539-134-10			
539-135	539-135-10			
539-136	539-136-10			
539-137				
539-138				
539-139				
539-140				
539-141				
539-142				
		539-143		
		539-144		
		539-145		
		539-146		
		539-147		
		539-148		
		539-149		
		539-150		
		539-151		
		539-152		
		539-153		
		539-154		

Spar type	Super-slim	
Model	AT112	
Accuracy at 20°C (μm)	STANDARD	HIGH-ACCURACY
L ₀ : Effective range	5+5L ₀ /1000	3+3L ₀ /1000
Maximum response speed	50m/min. (164ft/min.)	50m/min. (164ft/min.)
Order no. depending on L₀		
50mm (1.5")	539-251	539-251-10
70mm (2.5")	539-252	539-252-10
120mm (4.5")	539-253	539-253-10
170mm (6.5")	539-254	539-254-10
220mm (8.5")	539-255	539-255-10
270mm (10.5")	539-256	539-256-10
320mm (12.5")	539-257	539-257-10
370mm (14.5")	539-258	539-258-10
420mm (16.5")	539-259	539-259-10
470mm (18.5")	539-260	539-260-10
520mm (20")	539-261	539-261-10
570mm (22")	539-262	539-262-10
620mm (24")	539-263	539-263-10
670mm (26")	539-264	539-264-10
720mm (28")	539-265	539-265-10
770mm (30")	539-266	539-266-10
820mm (32")	539-267	539-267-10
920mm (36")	539-268	539-268-10
1020mm (40")	539-269	539-269-10

Spar type	Plunger construction	
Model	AT181	
Accuracy at 20°C (μm)	STANDARD	HIGH-ACCURACY
L ₀ : Effective range	5+5L ₀ /1000	3+3L ₀ /1000
Maximum response speed	50m/min. (164ft/min.)	50m/min. (164ft/min.)
Order no. depending on L₀		
100mm (4")	539-301	539-301-10
150mm (6")	539-302	539-302-10
200mm (8")	539-303	539-303-10
250mm (10")	539-304	539-304-10
300mm (12")	539-305	539-305-10
350mm (14")	539-306	539-306-10
400mm (16")	539-307	539-307-10
450mm (18")	539-308	539-308-10
500mm (20")	539-309	539-309-10
550mm (22")	539-310	539-310-10
600mm (24")	539-311	539-311-10

AT115

Economy Type Slim Spars

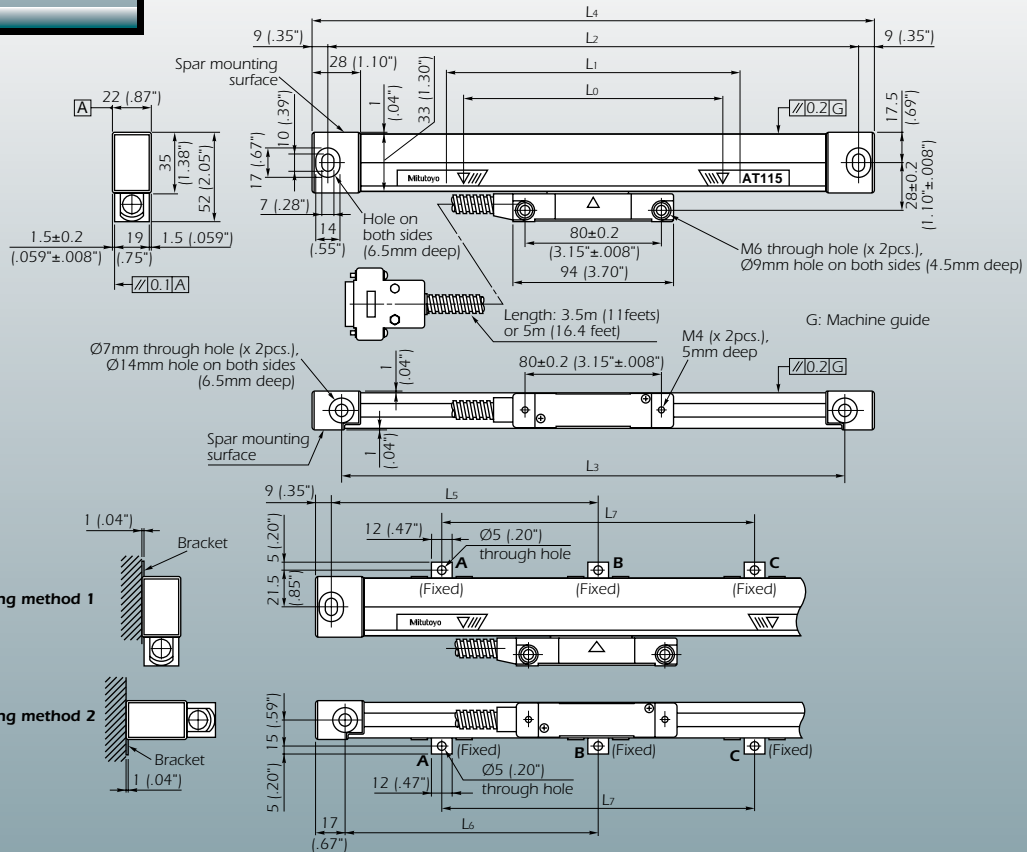

Mounting dimensions

Effective range L_0 mm (inch)	Travel range L_1 mm (inch)	Mount interval L_2 mm (inch)	Mount interval L_3 mm (inch)	Overall length L_4 mm (inch)	Supporting bracket			Signal cable length m (feet)	Mass kg (lbs.)
					L_5 mm (inch)	L_6 mm (inch)	L_7 mm (inch)		
100 (4")	120 (4.72")	258 (10.16")	242 (9.53")	276 (10.87")				3 (9.8)	1.0 (2.2)
150 (6")	170 (6.69")	308 (12.13")	292 (11.50")	326 (12.83")				3 (9.8)	1.0 (2.2)
200 (8")	220 (8.66")	358 (14.09")	342 (13.46")	376 (14.80")				3 (9.8)	1.0 (2.2)
250 (10")	270 (10.63")	408 (16.06")	392 (15.43")	426 (16.77")				3 (9.8)	1.1 (2.42)
300 (12")	330 (12.99")	468 (18.43")	452 (17.80")	486 (19.13")				3 (9.8)	1.1 (2.42)
350 (14")	380 (14.96")	518 (20.39")	502 (19.76")	536 (21.10")				3 (9.8)	1.1 (2.42)
400 (16")	430 (16.93")	568 (22.36")	552 (21.73")	586 (23.07")				3 (9.8)	1.2 (2.64)
450 (18")	480 (18.90")	618 (24.33")	602 (23.70")	636 (25.04")				3 (9.8)	1.2 (2.64)
500 (20")	540 (21.26")	678 (26.69")	662 (26.06")	696 (27.40")	339 (13.35")	331 (13.03")		3 (9.8)	1.2 (2.64)
600 (24")	640 (25.20")	778 (30.63")	762 (30.00")	796 (31.34")	389 (15.31")	381 (15.00")		3 (9.8)	1.3 (2.86)
700 (28")	740 (29.13")	878 (34.57")	862 (33.94")	896 (35.28")	439 (17.28")	431 (16.97")		3 (9.8)	1.3 (2.86)
750 (30")	780 (30.71")	918 (36.14")	902 (35.51")	936 (36.85")	459 (18.07")	451 (17.76")		3 (9.8)	1.3 (2.86)
800 (32")	840 (33.07")	978 (38.50")	962 (37.87")	996 (39.21")	489 (19.25")	481 (18.94")		3 (9.8)	1.4 (3.08)
900 (36")	940 (37.01")	1078 (42.44")	1062 (41.81")	1096 (43.15")	539 (21.22")	531 (20.91")		3 (9.8)	1.4 (3.08)
1000 (40")	1040 (40.94")	1178 (46.38")	1162 (45.75")	1196 (47.09")	589 (23.19")	581 (22.87")		5 (16.4)	1.8 (3.96)
1100 (44")	1140 (44.88")	1278 (50.31")	1262 (49.69")	1296 (51.02")			430 (16.93")	5 (16.4)	1.8 (3.96)
1200 (48")	1240 (48.82")	1378 (54.25")	1362 (53.62")	1396 (54.96")			460 (18.11")	5 (16.4)	1.9 (4.18)
1300 (52")	1340 (52.76")	1478 (58.19")	1462 (57.56")	1496 (58.90")			490 (19.29")	5 (16.4)	1.9 (4.18)
1400 (56")	1440 (56.69")	1578 (62.13")	1562 (61.50")	1596 (62.83")			530 (20.87")	5 (16.4)	2.0 (4.4)
1500 (60")	1540 (60.63")	1678 (66.06")	1662 (65.43")	1696 (66.77")			560 (22.05")	5 (16.4)	2.0 (4.4)

Mounting parts (provided as standard)

Items included	Quantity
Hex-socket head screw (M6x1x25)	2 pcs.
Hex-socket head screw (M4x0.7x25)	2 pcs.
Hex-socket head screw (M4x0.7x8)	6 pcs.
Plain washer (4mm nominal)	2 pcs.
Plain washer (6mm nominal)	2 pcs.
Cable clip	5 pcs.
Connector clamp	1 pc.
Spacer (0.3mm)	1 pc.
Spacer (0.4mm)	1 pc.
Spacer (0.5mm)	1 pc.
Spacer (0.6mm)	1 pc.

Note) When selecting the size of a Linear Scale for your application, make sure that the maximum travel range of the Linear Scale (L_1) is larger than the maximum travel range of the machine. Also, take into consideration selecting a size that the accuracy of the Linear Scale is guaranteed only within the range of the effective measuring length (L_0).

AT102 Standard-size Spars

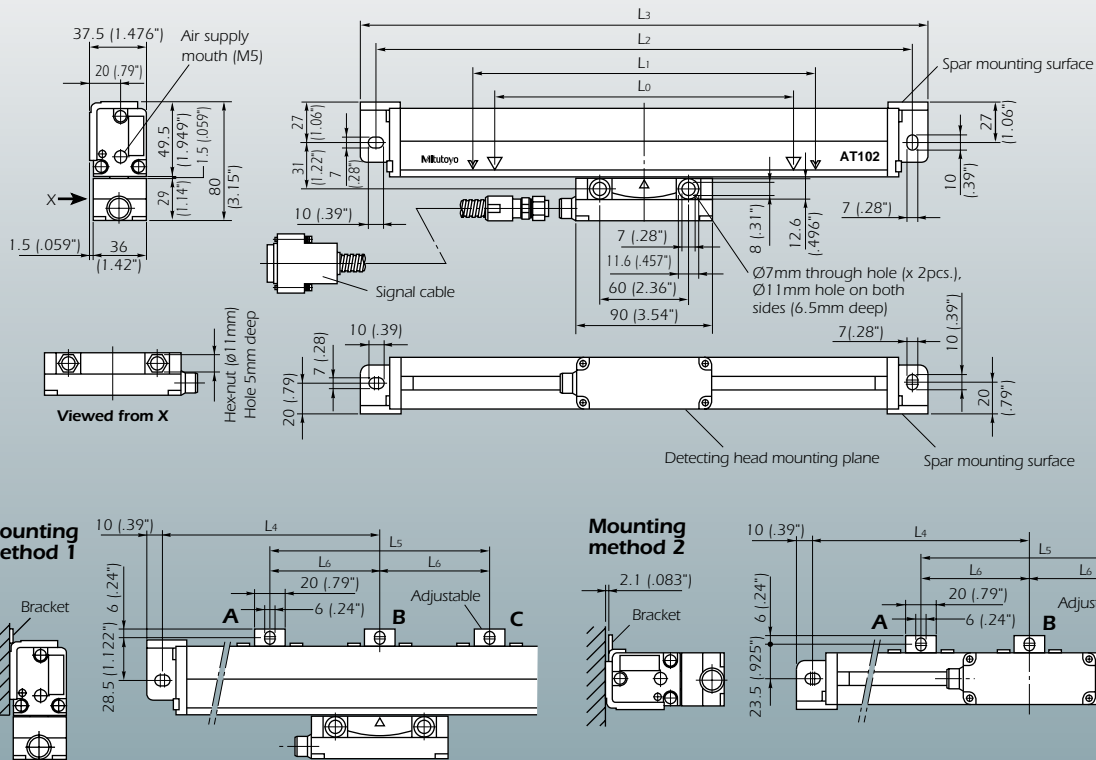

Mounting dimensions

Effective range L ₀ mm (inch)	Travel range L ₁ mm (inch)	Mount interval L ₂ mm (inch)	Overall length L ₃ mm (inch)	Supporting bracket			Signal cable length m (feet)	Mass kg (lbs.)
				L ₄ mm (inch)	L ₅ mm (inch)	L ₆ mm (inch)		
100 (4")	120 (4.72")	248 (9.76")	268 (10.55")				3 (9.8)	1.5 (3.30)
150 (6")	170 (6.69")	298 (11.73")	318 (12.52")				3 (9.8)	1.6 (3.52)
200 (8")	220 (8.66")	348 (13.70")	368 (14.49")				3 (9.8)	1.7 (3.74)
250 (10")	270 (10.63")	398 (15.67")	418 (16.46")				3 (9.8)	1.8 (3.96)
300 (12")	330 (12.99")	458 (18.03")	478 (18.82")				3 (9.8)	1.9 (4.18)
350 (14")	380 (14.96")	508 (20.00")	528 (20.79")				3 (9.8)	2.0 (4.40)
400 (16")	430 (16.93")	558 (21.97")	578 (22.76")				3 (9.8)	2.1 (4.62)
450 (18")	480 (18.90")	608 (23.94")	628 (24.72")				3 (9.8)	2.2 (4.84)
500 (20")	540 (21.26")	668 (26.30")	688 (27.09")				3 (9.8)	2.3 (5.06)
600 (24")	650 (25.59")	778 (30.63")	798 (31.42")				3 (9.8)	2.6 (5.72)
700 (28")	760 (29.92")	888 (34.96")	908 (35.75")				3 (9.8)	2.8 (6.16)
750 (30")	810 (31.89")	938 (36.93")	958 (37.72")				3 (9.8)	2.9 (6.38)
800 (32")	860 (33.86")	988 (38.90")	1008 (39.69")				3 (9.8)	3.0 (6.60)
900 (36")	960 (37.79")	1088 (42.83")	1108 (43.62")				3 (9.8)	3.3 (7.26)
1000 (40")	1060 (41.73")	1188 (46.77")	1208 (47.56")	594 (23.39")			5 (16.4)	3.7 (8.14)
1100 (44")	1160 (45.67")	1288 (50.71")	1308 (51.50")	644 (25.35")			5 (16.4)	4.0 (8.80)
1200 (48")	1260 (49.60")	1388 (54.65")	1408 (55.43")	694 (27.32")			5 (16.4)	4.2 (9.24)
1300 (52")	1360 (53.54")	1488 (58.58")	1508 (59.37")	744 (29.29")			5 (16.4)	4.4 (9.68)
1400 (56")	1460 (57.48")	1588 (62.52")	1608 (63.31")	794 (31.26")			5 (16.4)	4.6 (10.12)
1500 (60")	1560 (61.41")	1688 (66.46")	1708 (67.24")	844 (33.23")			5 (16.4)	4.8 (10.56)
1600 (64")	1690 (66.53")	1818 (71.57")	1838 (72.36")		610 (24.02")		5 (16.4)	5.1 (11.22)
1700 (68")	1790 (70.47")	1918 (75.51")	1938 (76.30")		650 (25.59")		5 (16.4)	5.3 (11.66)
1800 (72")	1890 (74.41")	2018 (79.45")	2038 (80.24")		670 (26.38")		5 (16.4)	5.5 (12.10)
2000 (80")	2100 (82.67")	2228 (87.72")	2248 (88.50")		740 (29.13")		5 (16.4)	6.0 (13.20)
2200 (88")	2300 (90.55")	2428 (95.59")	2448 (96.38")		800 (31.50")		5 (16.4)	6.4 (14.08)
2400 (96")	2500 (98.42")	2628 (103.46")	2648 (104.25")	1314 (51.73")	1300 (51.18")	650 (25.59")	7 (22.9)	7.1 (15.62)
2500 (100")	2600 (102.36")	2728 (107.40")	2748 (108.19")	1364 (53.70")	1340 (52.76")	670 (25.38")	7 (22.9)	7.3 (16.06)
2600 (104")	2700 (106.30")	2828 (111.34")	2848 (112.13")	1414 (55.67")	1400 (55.12")	700 (27.56")	7 (22.9)	7.5 (16.50)
2800 (112")	2900 (114.17")	3028 (119.21")	3048 (120.00")	1514 (59.60")	1500 (59.06")	750 (29.53")	7 (22.9)	7.9 (17.38)
3000 (120")	3100 (118.11")	3228 (127.09")	3248 (127.87")	1614 (63.99")	1600 (62.99")	800 (31.50")	7 (22.9)	8.3 (18.26)

Note) When selecting the size of a Linear Scale for your application, make sure that the maximum travel range of the Linear Scale (L₁) is larger than the maximum travel range of the machine. Also, take into consideration in selecting a size that the accuracy of the Linear Scale is guaranteed only within the range of the effective measuring length (L₀).

Mounting parts for the AT102 Series scale units (standard accessories) are shown on the next page.

AT102

Extra-long Spars

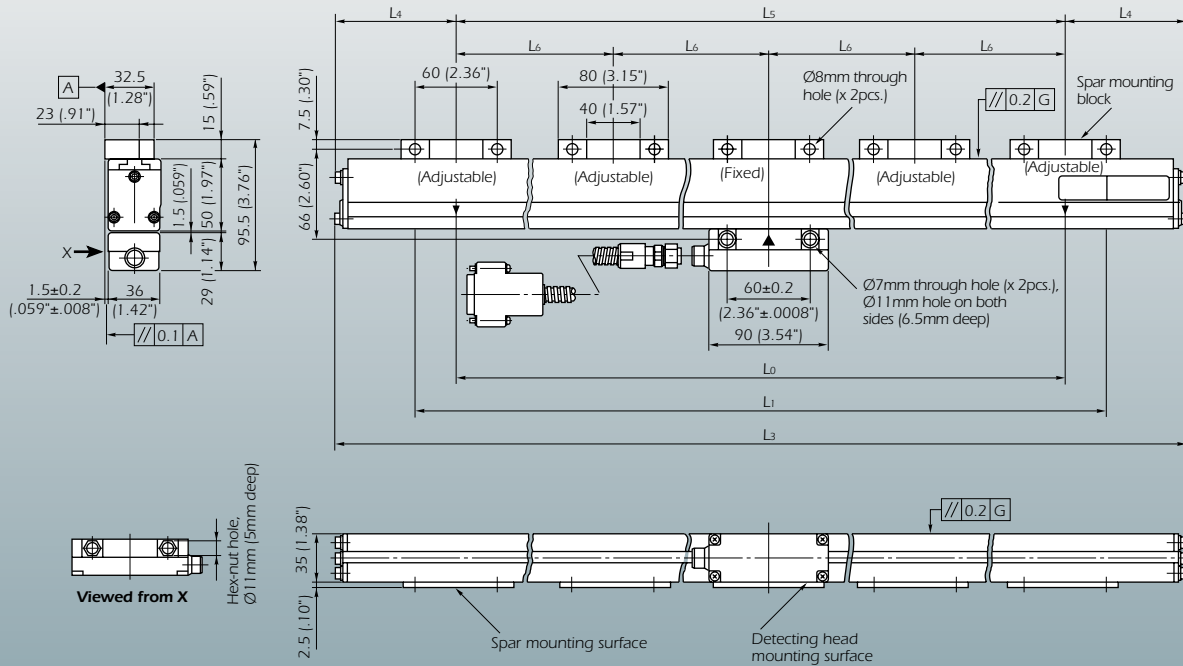

Mounting dimensions

Effective range L ₀ mm (inch)	Travel range L ₁ mm (inch)	Overall length L ₃ mm (inch)	Mounting block				Signal cable length m (feet)	Mass kg (lbs.)
			Blocks included	L ₄ mm (inch)	L ₅ mm (inch)	L ₆ mm (inch)		
3250 (130")	3350 (131.88")	3470 (136.61")	5 pcs.	135 (5.32")	3200 (125.98")	800 (31.50")	10 (32.8)	10.8 (23.76)
3500 (140")	3600 (141.73")	3720 (146.46")	5 pcs.	160 (6.30")	3400 (133.86")	850 (33.46")	10 (32.8)	11.4 (25.08)
3750 (150")	3850 (151.57")	3970 (156.30")	5 pcs.	125 (4.92")	3720 (146.46")	930 (36.61")	10 (32.8)	12.0 (26.40)
4000 (160")	4100 (161.42")	4220 (166.14")	5 pcs.	110 (4.33")	4000 (157.48")	1000 (39.37")	10 (32.8)	12.6 (27.72)
4250 (170")	4350 (171.26")	4470 (175.98")	5 pcs.	135 (5.32")	4200 (165.35")	1050 (41.34")	10 (32.8)	13.2 (29.04)
4500 (180")	4600 (181.10")	4720 (185.83")	5 pcs.	160 (6.30")	4400 (173.23")	1100 (43.31")	10 (32.8)	13.8 (30.36)
4750 (190")	4850 (191.94")	4970 (195.67")	7 pcs.	85 (3.35")	4800 (188.98")	800 (31.50")	15 (49.2)	15.2 (33.44)
5000 (200")	5100 (200.78")	5220 (205.51")	7 pcs.	120 (4.72")	4980 (196.06")	830 (32.68")	15 (49.2)	15.8 (34.76)
5250 (210")	5350 (210.63")	5470 (215.35")	7 pcs.	125 (4.92")	5220 (205.51")	870 (34.25")	15 (49.2)	16.4 (36.08)
5500 (220")	5600 (220.47")	5720 (225.20")	7 pcs.	130 (5.12")	5460 (214.41")	910 (35.83")	15 (49.2)	17.0 (37.40)
5750 (230")	5850 (230.31")	5970 (235.24")	7 pcs.	135 (5.32")	5700 (224.41")	950 (37.40")	15 (49.2)	17.6 (38.72)
6000 (240")	6100 (240.16")	6220 (244.88")	7 pcs.	110 (4.33")	6000 (236.22")	1000 (39.37")	15 (49.2)	18.2 (40.04)

Note) When selecting the size of a Linear Scale for your application, make sure that the maximum travel range of the Linear Scale (L₁) is larger than the maximum travel range of the machine. Also, take into consideration in selecting a size that the accuracy of the Linear Scale is guaranteed only within the range of the effective measuring length (L₀).

Mounting parts (provided as standard)

Type of spar	Standard-size	Extra-long
Effective range L ₀	100mm (4") - 3000mm (120")	3250mm (130") - 6000mm (240")
Items included	<ul style="list-style-type: none"> ▪ Hex-socket head screw (M6x1x40) 2 pcs. ▪ Hex-socket head screw (M6x1x16) 2 pcs. ▪ Hex-socket head screw (M4x0.7x8) 5 pcs. ▪ Spring washer (6mm nominal) 2 pcs. ▪ Plain washer (6mm nominal) 2 pcs. ▪ Cable clip 5 pcs. ▪ Spacers (0.3mm) 1 pc. ▪ Spacer (0.4mm) 1 pc. ▪ Spacer (0.5mm) 1 pc. ▪ Spacer (0.6mm) 1 pc. 	<ul style="list-style-type: none"> ▪ Hex-socket head screw (M6x1x40) 2 pcs. ▪ Hex-socket head screw (M6x1x30) 14 pcs. ▪ Hex-socket head screw (M4x0.7x8) 7 pcs. ▪ Spring washer (6mm nominal) 14 pcs. ▪ Plain washer (6mm nominal) 14 pcs. ▪ Cable clip 7 pcs. ▪ Spacer (0.3mm) 1 pc. ▪ Spacer (0.4mm) 1 pc. ▪ Spacer (0.5mm) 1 pc. ▪ Spacer (0.6mm) 1 pc.

Remarks: Dustproofing and splashproofing of the AT102 model scale units can be improved by supplying clean and dry air to the main spar.
(Air pressure required: 50kPa, Air flow rate: 10 to 20 normal liters per minute)

AT111 Slim Spars

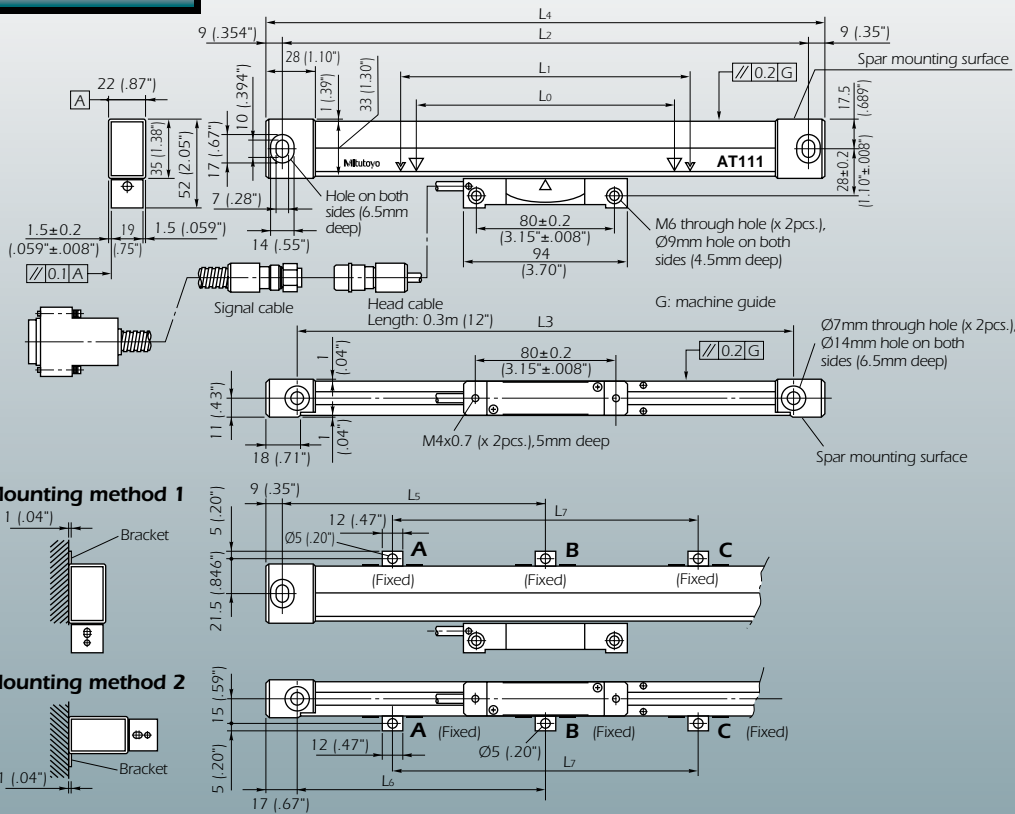

Mounting dimensions

Effective range L ₀ mm (inch)	Travel range L ₁ mm (inch)	Mount interval L ₂ mm (inch)	Mount interval L ₃ mm (inch)	Overall length L ₄ mm (inch)	Supporting bracket			Signal cable length m (feet)	Mass kg (lbs.)
					L ₅ mm (inch)	L ₆ mm (inch)	L ₇ mm (inch)		
100 (4")	120 (4.72")	258 (10.16")	242 (9.53")	276 (10.87")				3 (9.8)	1.0 (2.2)
150 (6")	170 (6.69")	308 (12.13")	292 (11.50")	326 (12.83")				3 (9.8)	1.0 (2.2)
200 (8")	220 (8.66")	358 (14.09")	342 (13.46")	376 (14.80")				3 (9.8)	1.0 (2.2)
250 (10")	270 (10.63")	408 (16.06")	392 (15.43")	426 (16.77")				3 (9.8)	1.1 (2.42)
300 (12")	330 (12.99")	468 (18.43")	452 (17.80")	486 (19.13")				3 (9.8)	1.1 (2.42)
350 (14")	380 (14.96")	518 (20.39")	502 (19.76")	536 (21.10")				3 (9.8)	1.1 (2.42)
400 (16")	430 (16.93")	568 (22.36")	552 (21.73")	586 (23.07")				3 (9.8)	1.2 (2.64)
450 (18")	480 (18.90")	618 (24.33")	602 (23.70")	636 (25.04")				3 (9.8)	1.2 (2.64)
500 (20")	540 (21.26")	678 (26.69")	662 (26.06")	696 (27.40")	339 (13.35")	331 (13.03")		3 (9.8)	1.2 (2.64)
600 (24")	640 (25.20")	778 (30.63")	762 (30.00")	796 (31.34")	389 (15.31")	381 (15.00")		3 (9.8)	1.3 (2.86)
700 (28")	740 (29.13")	878 (34.57")	862 (33.94")	896 (35.28")	439 (17.28")	431 (16.97")		3 (9.8)	1.3 (2.86)
750 (30")	780 (30.71")	918 (36.14")	902 (35.51")	936 (36.85")	459 (18.07")	451 (17.76")		3 (9.8)	1.3 (2.86)
800 (32")	840 (33.07")	978 (38.50")	962 (37.87")	996 (39.21")	489 (19.25")	481 (18.94")		3 (9.8)	1.4 (3.08)
900 (36")	940 (37.01")	1078 (42.44")	1062 (41.81")	1096 (43.15")	539 (21.22")	531 (20.91")		3 (9.8)	1.4 (3.08)
1000 (40")	1040 (40.94")	1178 (46.38")	1162 (45.75")	1196 (47.09")	589 (23.19")	581 (22.87")		5 (16.4)	1.8 (3.96)
1100 (44")	1140 (44.88")	1278 (50.31")	1262 (49.69")	1296 (51.02")			430 (16.93")	5 (16.4)	1.8 (3.96)
1200 (48")	1240 (48.82")	1378 (54.25")	1362 (53.62")	1396 (54.96")			460 (18.11")	5 (16.4)	1.9 (4.18)
1300 (52")	1340 (52.76")	1478 (58.19")	1462 (57.56")	1496 (58.90")			490 (19.29")	5 (16.4)	1.9 (4.18)
1400 (56")	1440 (56.69")	1578 (62.13")	1562 (61.50")	1596 (62.83")			530 (20.87")	5 (16.4)	2.0 (4.4)
1500 (60")	1540 (60.63")	1678 (66.06")	1662 (65.43")	1696 (66.77")			560 (22.05")	5 (16.4)	2.0 (4.4)

Mounting parts (provided as standard)

Items included	Quantity
Hex-socket head screw (M6x1x25)	2 pcs.
Hex-socket head screw (M4x0.7x25)	2 pcs.
Hex-socket head screw (M4x0.7x8)	6 pcs.
Plain washer (4mm nominal)	2 pcs.
Plain washer (6mm nominal)	2 pcs.
Cable clip	5 pcs.
Connector clamp	1 pc.
Spacer (0.3mm)	1 pc.
Spacer (0.4mm)	1 pc.
Spacer (0.5mm)	1 pc.
Spacer (0.6mm)	1 pc.

Note) When selecting the size of a Linear Scale for your application, make sure that the maximum travel range of the Linear Scale (L₁) is larger than the maximum travel range of the machine. Also, take into consideration selecting a size that the accuracy of the Linear Scale is guaranteed only within the range of the effective measuring length (L₀).

AT112 Super-slim Spars

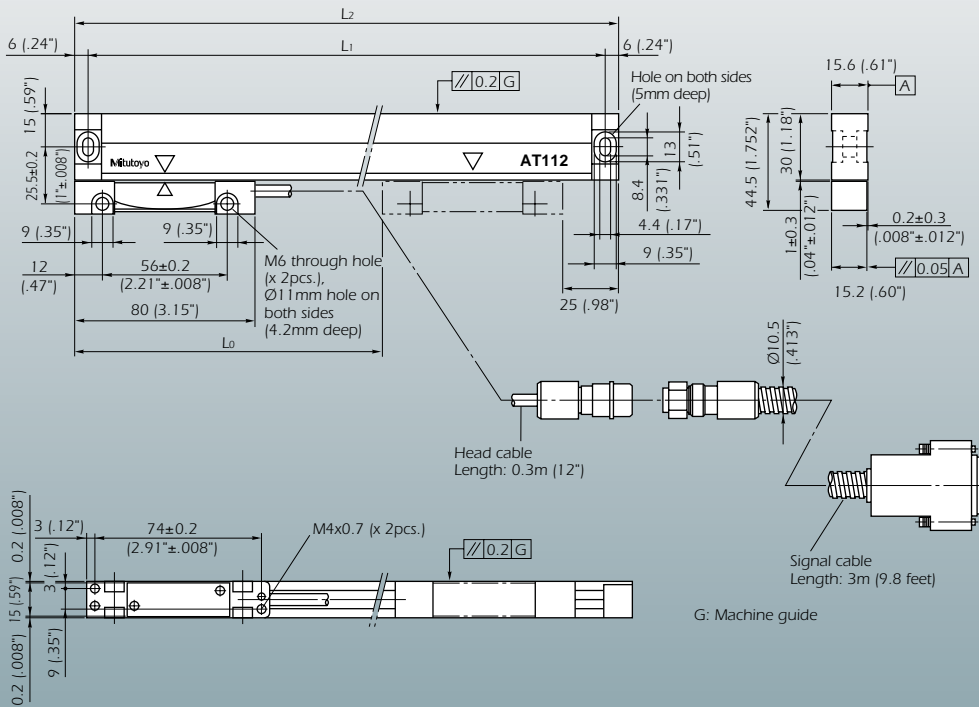

Mounting dimensions

Effective range L _o mm (inch)	Mount interval L ₁ mm (inch)	Overall length L ₂ mm (inch)	Signal cable length m (feet)	Mass kg (lbs.)
50 (1.5")	143 (5.63")	155 (6.10")	3 (9.8)	0.72 (1.58)
70 (2.5")	163 (6.42")	175 (10.89")	3 (9.8)	0.74 (1.63)
120 (4.5")	213 (8.39")	225 (8.86")	3 (9.8)	0.80 (1.76)
170 (6.5")	263 (10.35")	275 (10.83")	3 (9.8)	0.85 (1.87)
220 (8.5")	313 (12.32")	325 (12.80")	3 (9.8)	0.90 (1.98)
270 (10.5")	363 (14.29")	375 (14.76")	3 (9.8)	0.95 (2.09)
320 (12.5")	413 (16.26")	425 (16.73")	3 (9.8)	1.00 (2.20)
370 (14.5")	463 (18.23")	475 (18.70")	3 (9.8)	1.05 (2.31)
420 (16.5")	513 (20.20")	525 (20.67")	3 (9.8)	1.10 (2.42)
470 (18.5")	563 (22.17")	575 (22.64")	3 (9.8)	1.15 (2.53)
520 (20")	613 (24.13")	625 (24.61")	3 (9.8)	1.20 (2.64)
570 (22")	663 (26.10")	675 (26.57")	3 (9.8)	1.25 (2.75)
620 (24")	713 (28.07")	725 (28.54")	3 (9.8)	1.30 (2.86)
670 (26")	763 (30.04")	775 (30.51")	3 (9.8)	1.35 (2.97)
720 (28")	813 (32.01")	825 (32.48")	3 (9.8)	1.40 (3.08)
770 (30")	863 (33.98")	875 (34.45")	3 (9.8)	1.45 (3.19)
820 (32")	913 (35.94")	925 (36.42")	3 (9.8)	1.50 (3.30)
920 (36")	1013 (39.88")	1025 (40.35")	3 (9.8)	1.56 (3.43)
1020 (40")	1113 (43.82")	1125 (44.29")	3 (9.8)	1.62 (3.56)

Note) When selecting the size of a Linear Scale for your application, make sure that the maximum travel range of the Linear Scale (L₁) is larger than the maximum travel range of the machine. Also, take into consideration in selecting a size that the accuracy of the Linear Scale is guaranteed only within the range of the effective measuring length (L_o).

Mounting parts (provided as standard)

Items included		
▪ Hex-socket head screw (M4x0.7x20)	4 pcs.	
▪ Hex-socket head screw (M4x0.7x8)	6 pcs.	
▪ Spring washer (4mm nominal)	4 pcs.	
▪ Plain washer (4mm nominal)	4 pcs.	
▪ Cable clip	5 pcs.	
▪ Connector clamp	1 pc.	
▪ Spacer (0.3mm)	1 pc.	
▪ Spacer (0.4mm)	1 pc.	
▪ Spacer (0.5mm)	1 pc.	
▪ Spacer (0.6mm)	1 pc.	

AT181

Plunger Type Spars

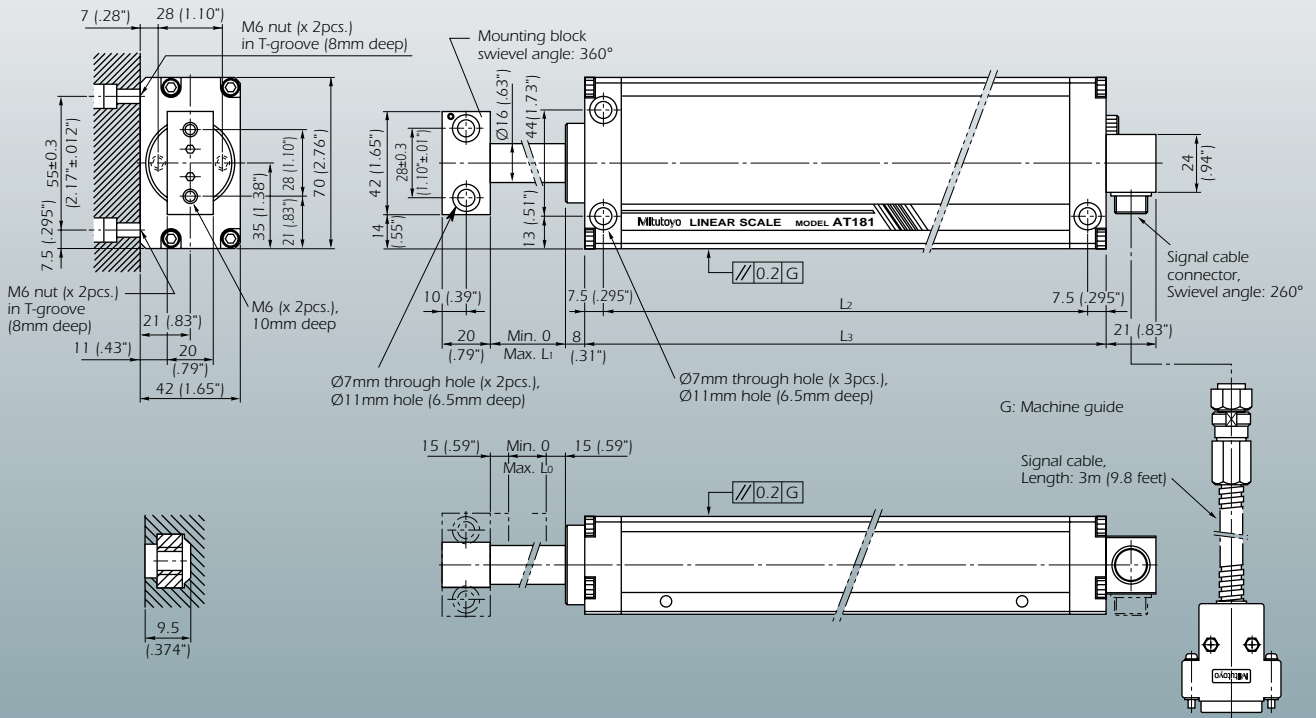

Mounting dimensions

Effective range L ₀ mm (inch)	Travel range L ₁ mm (inch)	Mount interval L ₂ mm (inch)	Main spar length L ₃ mm (inch)	Signal cable length m (feet)	Mass kg (lbs.)
100 (4")	130 (5.11")	255 (10.04")	270 (10.63")	3 (9.8)	1.7 (3.74)
150 (6")	180 (7.08")	305 (12.01")	320 (12.60")	3 (9.8)	1.9 (4.18)
200 (8")	230 (9.05")	355 (13.98")	370 (14.57")	3 (9.8)	2.1 (4.62)
250 (10")	280 (11.02")	405 (15.94")	420 (16.54")	3 (9.8)	2.3 (5.06)
300 (12")	330 (12.99")	455 (17.91")	470 (18.50")	3 (9.8)	2.5 (5.50)
350 (14")	380 (14.96")	505 (19.88")	520 (20.47")	3 (9.8)	2.7 (5.94)
400 (16")	430 (16.93")	555 (21.85")	570 (22.44")	3 (9.8)	2.9 (6.38)
450 (18")	480 (18.90")	605 (23.82")	620 (24.41")	3 (9.8)	3.1 (6.82)
500 (20")	530 (20.87")	655 (25.79")	670 (26.38")	3 (9.8)	3.3 (7.26)
550 (22")	580 (22.83")	705 (27.76")	720 (28.35")	3 (9.8)	3.5 (7.70)
600 (24")	630 (24.83")	755 (29.72")	770 (30.31")	3 (9.8)	3.7 (8.14)

Note) When selecting the size of a Linear Scale for your application, make sure that the maximum travel range of the Linear Scale (L₁) is larger than the maximum travel range of the machine. Also, take into consideration in selecting a size that the accuracy of the Linear Scale is guaranteed only within the range of the effective measuring length (L₀).

Caution in mounting and handling Linear Scales

Selecting the scale unit mounting position and mounting method

Take note of the following four points when determining the scale unit mounting position and orientation.

Ease of mounting

Mount the scale unit making sure that the unit including the detector head and the cables does not interfere with any part of the machine. To facilitate mounting, mount the scale unit and the brackets on machined surfaces wherever possible.

Protection from machining fluids and swarf (mounting orientation)

The scale unit is constructed in such a way that machining fluids and swarf cannot easily enter into the interior of the unit. However, since the openings are protected from entry of foreign material with rubber lips only, avoid directly exposing the scale unit to machining fluids and swarf. Select the mounting orientation of the scale unit after carefully considering the direction in which machining fluids and swarf are sprayed and scattered.

Accuracy consideration

The total system accuracy of the machine on which the scale unit is mounted is not only determined by the scale unit accuracy but by the machine accuracy as well. Particularly for machines with side tables, geometrical errors may occur, depending on the straightness of moving parts; Thus, the scale unit must be mounted in a way that these errors are minimized. If the slide table moves not linearly but curvilinearly, errors occur in proportion to the distance "L" between the scale unit and the machining point (cutter position). Thus, mount the scale unit in a position that minimizes "L".

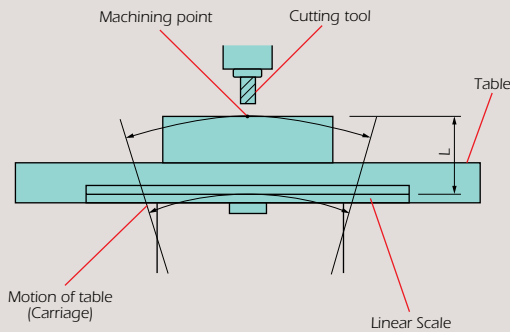

Other considerations

- If the detector head moves, the signal cables also move with the slide table. Thus, take note of this when laying out the signal cables. It is therefore recommended to mount the scale unit on the moving part of the machine.
- Mount the scale unit in place where it is not directly subjected to the airflow. When removing swarf using an air gun, be careful of flying swarf.
- The scale unit must be mounted in a place where maintenance can be easily performed in case unit trouble occurs.

Checking parallelism and adjustment of scale unit

In order to get the most of the performance of the scale unit, the scale unit must be mounted parallel to the machine guide (machining axis). Take note that incorrect mounting may cause the scale unit to bend or twist.

Checking parallelism

Use a dial indicator as shown in the figure below. To adjust the parallelism between the scale unit and the machine guide, check the parallelism while manually moving the machine's movable part such as the slide table, or measure the parallelism with reference to the guide rail of the machine or equivalent reference surface.

- Parallelism tolerance: Refer to each figure on dimensions.
- Checking direction: Back/forward direction on mounting surface and directions along mounting surface (up and down).
- Checking position: Position of scale unit around the mounting blocks.

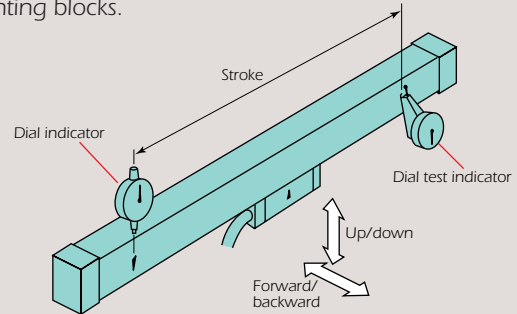

Adjusting parallelism

Adjust the parallelism to within 0.2mm. Spacers used in adjustment are not included in the accessories. Please arrange for them as necessary.

- Adjusting the mounting surface back/forward: Readjust the mounting positions of the brackets or place spacers between the scale unit mounting surface and the mounting blocks.
- Adjusting along (up and down) the mounting surface: Adjust the parallelism by sliding the mounting block on the mounting surface.

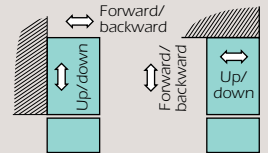

Layouting signal cable

Take note of the following points when layouting signal cables.

When the cable is fixed

The radius of curvature of the signal cable must be larger than 50mm.

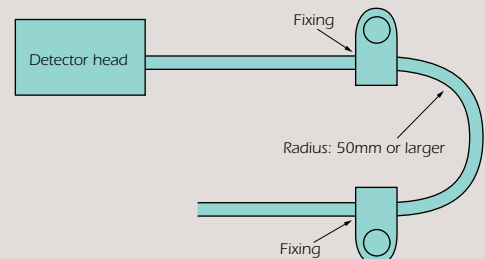

When the cable is movable

When the detector head is movable, it carries the signal cable with it during operation. Take care, in such a case, that the radius of curvature of the signal cable is not smaller than 100mm and excessive force is not applied to the cable. It is a good idea to protect the cable with a flexible support cover.

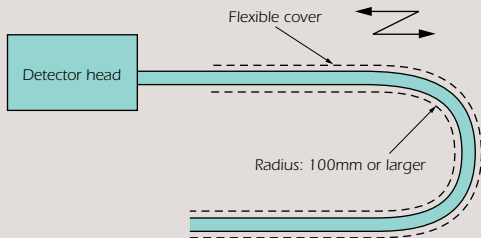

Note: Take care that the signal cables does not interfere or are not rubbed with any part of the machine.

Other considerations

The signal cable is durable enough to withstand repeated bending up to approximately 2 million times (when the bending radius is 100mm). When repeated bending exceeding 2 million times is expected, the signal cable should be considered as a consumable part. Have an extension cable ready in such a case so that the slider unit can be replaced to facilitate maintenance.

Improving the dust- and splash-proofing

On the assembly type Linear Scale AT102 the dustproofing and splashproofing can be improved by supplying dry and clean air into the spar. Pipe to either of the screw holes (M5) located on the both ends of the main scale for the air supply.

- Applicable Linear Scale: AT102
- Supplied air pressure: 0.1MPa (approx. 1kgf/cm²)
- Air flow rate: 10 to 20 liters/min.

Recommended air supply system

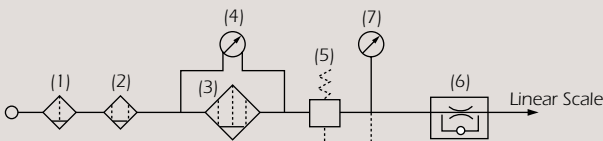

Air supply equipment	Specifications
(1) Air filter A	Filterability: 5 μ m
(2) Air filter B	Filterability: 0.3 μ m, Oil removal rate: 99.9% or more
(3) Air filter C	Filterability: 0.01 μ m, Oil removal rate: 99.9999% or more
(4) Differential pressure gage	For monitoring the life of the air filter C
(5) Air regulator	Pressure setting: 0.1MPa (1kgf/cm ²)
(6) Flow control valve	Flow setting: 10 to 20 liters/min.
(7) Pressure gage	Pressure: 0.1MPa (1kgf/cm ²)

Note 1: Do not supply excessive amount of air, since this may draw in the dust around the scale unit.

Note 2: When air in the air supply system contains humidity, connect an air dryer to the front of (1) Air filter A and dry the air.

Resonance point of Linear Scale

Each object has a natural frequency, depending on its shape, length, and the type of material. The Linear Scale frame is not an exception. It has its natural frequency and thereby resonates at a certain frequency. In general, this will not cause a problem, since a machine tool and the Linear Scale frame have different natural frequencies under normal machining conditions. However, when the natural frequency of the machine tool body and the Linear Scale coincide due to a special processing condition, the following counter-measures can be taken:

[What to do when the machine and the Linear Scale have the same natural frequency]

1. Increase rigidity of the mounting bracket for the scale.
2. Add a mid-support to the middle of the scale to shift its resonance point.
3. Mount the Linear Scale at a place where the frequency of the machine tool cannot be easily transmitted.
4. Limit the machine process conditions to be within a specific range in which the natural frequencies of the machine tool and the scale do not coincide.

Maintenance of Dust-proof rubber lips

In order to maintain and extend the life of the dust-proof rubber lips, it is recommended that a small amount of silicon lubricant be applied to the joint of the rubber and the detector head once a year.

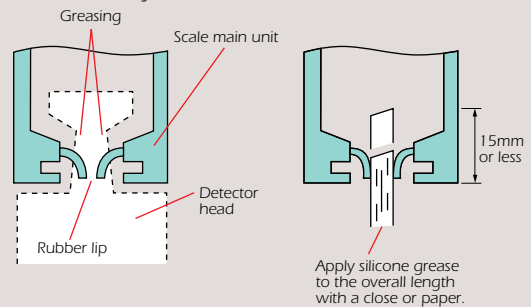

Linear Scale Evaluation Methods

- **Testing within the operation temperature range**
The test has proven that there is no abnormality of functions and signals when the Linear Scale is used within the specified operating temperature range.
- **Temperature cycle (dynamic characteristics) test**
The test has proven that there is no abnormality when the Linear Scale is used under the condition of which the ambient temperature continuously changes within the specific range.
- **Vibration test (Sweep test)**
The test has proven that Linear Scale functions without abnormality when used within the frequency range between 30Hz and 300Hz at a given acceleration (3G).
- **Noise test**
In accordance with the EMC Directives, EN55011:1991 Group 1 Class B, and EN50082-1:1992
- **Crate Drop Test**
In accordance with the heavy equipment drop test (JISZ20200) specified in the JIS.

OPTIONAL ACCESSORIES

Touch-signal probes



Shank diameter	Order no.
20mm	938140
32mm	935094
.5"	902329

Foot switch



965004

Extension cables



Extension cables Type A for AT102/111/112/181

Cable length	Order no.
2m (6.5ft)	09AAA033A
5m (16.4ft)	09AAA033B
7m (22.9ft)	09AAA033C

Note) Do not allow the entire length of the cables to exceed 20m.



Extension cables Type B for AT115*

Cable length	Order no.
2m (6.5ft)	09AAA720A
5m (16.4ft)	09AAA720B
7m (22.9ft)	09AAA720C

*Also can be used for AT102/111/112/181.
Note) Do not allow the entire length of the cables to exceed 20m.

Zero-set remote controller



09CAA335

Programmable remote controller



09CAA384

Coordinate Measuring Machines	_____
Vision Measuring Systems	_____
Surface-, Form- and Contour Measurement	_____
Digital Scale and DRO Systems	_____
Optical Measuring	_____
Sensor Systems	_____
Hardness Measuring	_____
Small Tool Instruments and Data Management	_____

Mitutoyo America Corporation
www.mitutoyo.com

Michigan
Phone: (734) 459-2810

Illinois
Phone: (630) 978-5385

California
Phone: (626) 961-9661

M³ Solution Center

Massachusetts
Phone: (978) 692-8765

Indiana
Phone: (317) 577-6070

North Carolina
Phone: (704) 875-8332

Job No. 11B-11

Mitutoyo

Note: All information regarding our products, and in particular the illustrations, drawings, dimensional and performance data contained in this pamphlet, as well as other technical data are to be regarded as approximate average values. We therefore reserve the right to make changes to the corresponding designs, dimensions and weights. The stated standards, similar technical regulations, descriptions and illustrations of the products were valid at the time of printing. In addition, the latest applicable version of our General Trading Conditions will apply. Only quotations submitted by ourselves may be regarded as definitive.